

Small Signal Schottky Diode

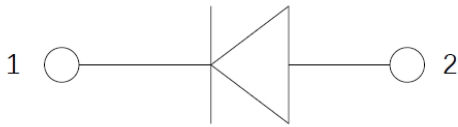
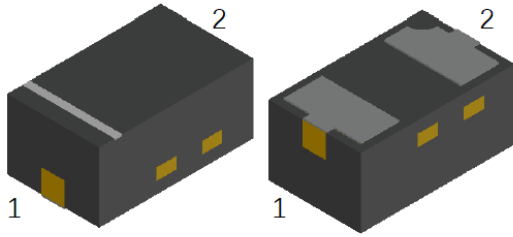

Features

- Low Forward Voltage
- Epoxy Meets UL 94 V-0 Flammability Rating
- High Conductance
- Lead Free Finish/RoHS Compliant
- Small package saves board space
- Moisture Sensitivity Level 3
- V_R 30V
- I_{FAV} 200mA

Mechanical Data

- **Package:** DFN1006-2L
- **Terminals:** Tin plated leads, solderable per J-STD-002 and JESD22-B102
- **Polarity:** Cathode line denotes the cathode end
- **Marking:** F1

■Maximum Ratings ($T_a=25^\circ\text{C}$ Unless otherwise specified)

PARAMETER	SYMBOL	UNIT	Conditions	VALUE
Reverse voltage	V_R	V		30
Non-repetitive Peak forward surge current	I_{FSM}	A	$t_p=8.3\text{ms}$, half sine	1
Repetitive Peak Forward Current	I_{FRM}	A	$t_p=1\text{ms}$, $\delta=0.25$	0.5
Average forward current	I_{FAV}	mA		200
Power dissipation	P_D	mW		100
Junction temperature	T_j	$^\circ\text{C}$		125
Storage temperature range	T_{stg}	$^\circ\text{C}$		-65 ~+125

■Electrical Characteristics ($T_a=25^\circ\text{C}$ Unless otherwise specified)

PARAMETER	Symbol	UNIT	Conditions	Min	Max
Breakdown Voltage	V_R	V	$I_R=500\mu\text{A}$	30	
Forward Voltage	V_F	V	$I_F=200\text{mA}$		0.5
Reverse Leakage Current	I_R	μA	$V_R=10\text{V}$		30

■Ordering Information (Example)

PREFERRED P/N	UNIT WEIGHT(mg)	MINIMUM PACKAGE(pcs)	INNER BOX QUANTITY(pcs)	OUTER CARTON QUANTITY(pcs)	DELIVERY MODE
RB521S-30L2	Approximate 0.9	10K	100K	400K	Tape & Reel

■ Characteristics (Typical)

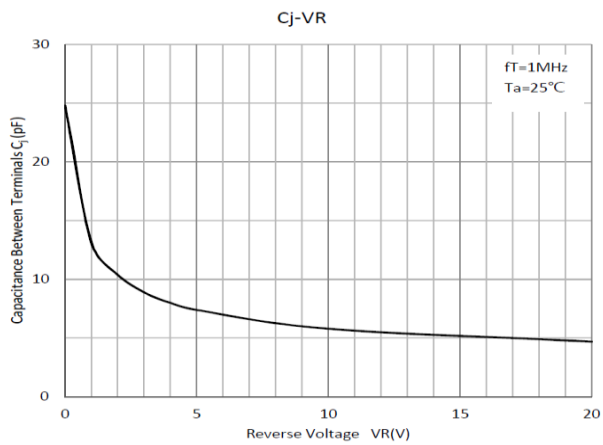
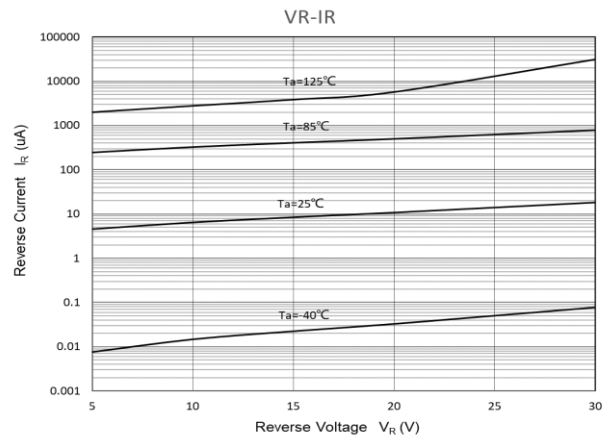
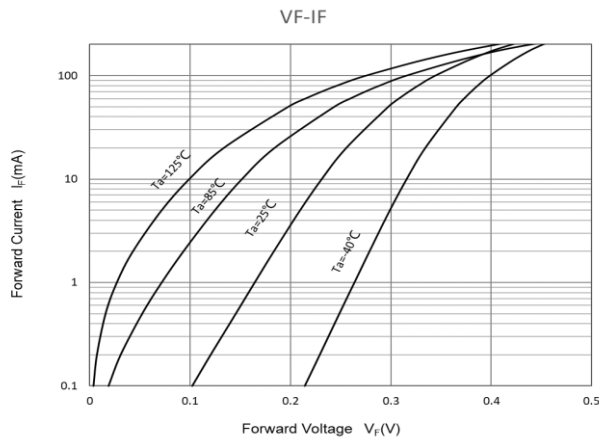

■ Outline Dimensions

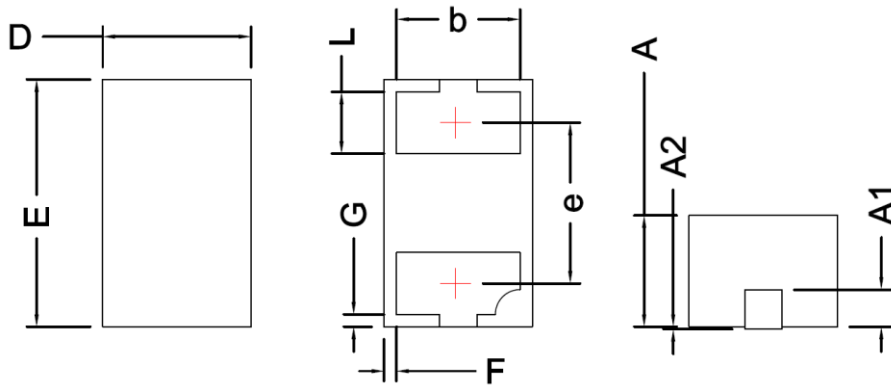

SYMBOL	MILLIMETER		
	MIN	NOM	MAX
D	0.50	0.60	0.70
E	0.90	1.00	1.10
A	0.35	0.45	0.55
A1	0.15 BSC		
A2			0.10
F	0.005		
G	0.005		
L	0.15	0.25	0.35
b	0.41	0.50	0.59
e	0.65 BSC		

■ Soldering Footprint

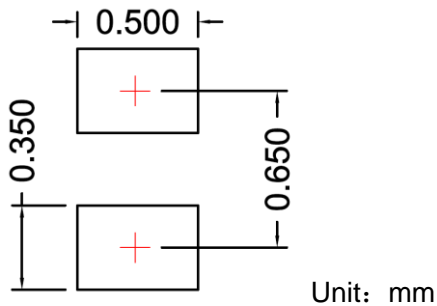



Disclaimer

The information presented in this document is for reference only. Yangzhou Yangjie Electronic Technology Co., Ltd. reserves the right to make changes without notice for the specification of the products displayed herein to improve reliability, function or design or otherwise.

The product listed herein is designed to be used with ordinary electronic equipment or devices, and not designed to be used with equipment or devices which require high level of reliability and the malfunction of which would directly endanger human life (such as medical instruments, transportation equipment, aerospace machinery, nuclear-reactor controllers, fuel controllers and other safety devices), Yangjie or anyone on its behalf, assumes no responsibility or liability for any damages resulting from such improper use of sale.

This publication supersedes & replaces all information previously supplied. For additional information, please visit our website [http:// www.21yangjie.com](http://www.21yangjie.com) , or consult your nearest Yangjie's sales office for further assistance.