

## NPN Transistor

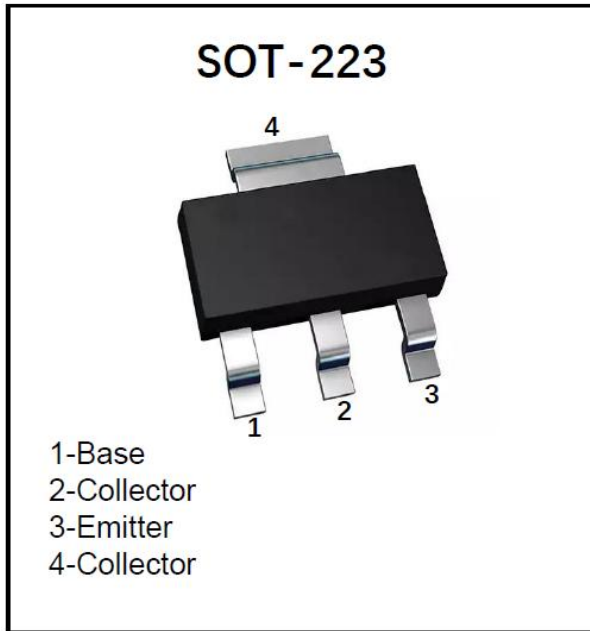

### Features

- Epoxy meets UL-94 V-0 flammability rating
- Halogen free available upon request by adding suffix "HF"
- Moisture Sensitivity Level 1

### Mechanical Data

- **Package:** SOT-223
- **Terminals:** Tin plated leads, solderable per J-STD-002 and JESD22-B102
- **Marking:** CZT5551

### ■Equivalent circuit

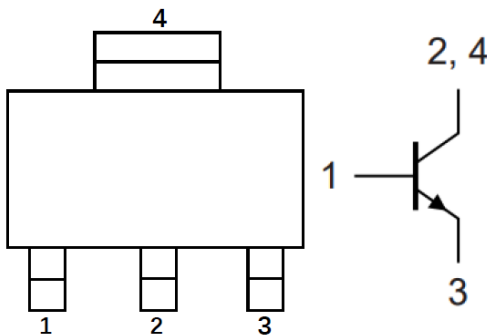

### ■Maximum Ratings (Ta=25°C unless otherwise noted)

| Item                                        | Symbol          | Unit | Conditions            | Value       |
|---------------------------------------------|-----------------|------|-----------------------|-------------|
| Minimum Collector-Emitter Voltage           | $V_{CEO}$       | V    | $I_C=1mA, I_B=0$      | 160         |
| Minimum Collector-Base Voltage              | $V_{CBO}$       | V    | $I_C=100\mu A, I_E=0$ | 180         |
| Minimum Emitter-Base Voltage                | $V_{EBO}$       | V    | $I_E=10\mu A, I_C=0$  | 6           |
| Collector Current                           | $I_C$           | A    |                       | 0.6         |
| Power Dissipation                           | $P_D$           | W    |                       | 1           |
| Thermal Resistance From Junction To Ambient | $R_{\theta JA}$ | °C/W |                       | 125         |
| Operation Junction Temperature              | $T_j$           | °C   |                       | -55 to +150 |
| Storage Temperature                         | $T_{stg}$       | °C   |                       | -55 to +150 |



# CZT5551

## ■Electrical Characteristics (Ta=25°C unless otherwise noted)

| Item                                 | Symbol         | Unit | Conditions                                 | Min | Max  |
|--------------------------------------|----------------|------|--------------------------------------------|-----|------|
| Collector-Emitter Voltage            | $V_{CE0}$      | V    | $I_C=1mA_{dc}, I_B=0$                      | 160 | -    |
| Collector-Base Voltage               | $V_{CBO}$      | V    | $I_C=100\mu A_{dc}, I_E=0$                 | 180 | -    |
| Emitter-Base Voltage                 | $V_{EBO}$      | V    | $I_E=10\mu A_{dc}, I_C=0$                  | 6.0 | -    |
| Collector-base Cut-off Current       | $I_{CBO}$      | nA   | $V_{CB}=120V_{dc}$                         | -   | 50   |
| Emitter-base Cut-off Current         | $I_{EBO}$      | nA   | $V_{EB}=4.0V_{dc}$                         | -   | 50   |
| DC Current Gain                      | $h_{FE}$       |      | $I_C=1.0mA, V_{CE}=5.0V_{dc}$              | 80  | -    |
|                                      |                |      | $I_C=10mA, V_{CE}=5.0V_{dc}$               | 100 | 300  |
|                                      |                |      | $I_C=50mA, V_{CE}=5.0V_{dc}$               | 30  | -    |
| Collector-Emitter Saturation Voltage | $V_{CE(sat)1}$ | V    | $I_C=10mA, I_B=1.0mA$                      | -   | 0.15 |
|                                      | $V_{CE(sat)2}$ | V    | $I_C=50mA, I_B=5.0mA$                      | -   | 0.2  |
| Base-Emitter Saturation Voltage      | $V_{BE(sat)1}$ | V    | $I_C=10mA, I_B=1.0mA$                      | -   | 1    |
|                                      | $V_{BE(sat)2}$ | V    | $I_C=50mA, I_B=5.0mA$                      | -   | 1    |
| Output Capacitance                   | $C_{ob}$       | pF   | $V_{CB}=10V_{dc}, I_E=0, f=1MHz$           | -   | 6    |
| Transition frequency                 | $f_T$          | MHz  | $I_C=10mA_{dc}, V_{CE}=5.0V_{dc}, f=30MHz$ | 100 | 300  |

## ■Ordering Information (Example)

| PREFERRED P/N | PACKING CODE | UNIT WEIGHT(g)   | MINIMUM PACKAGE(pcs) | INNER BOX QUANTITY(pcs) | OUTER CARTON QUANTITY(pcs) | DELIVERY MODE |
|---------------|--------------|------------------|----------------------|-------------------------|----------------------------|---------------|
| CZT5551       | F2           | Approximate 0.11 | 2500                 | 5000                    | 25000                      | 13" reel      |

## ■Characteristics (Typical)

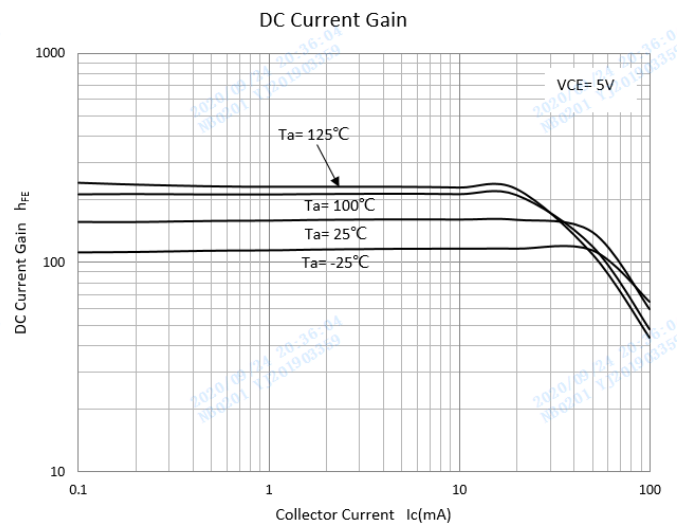
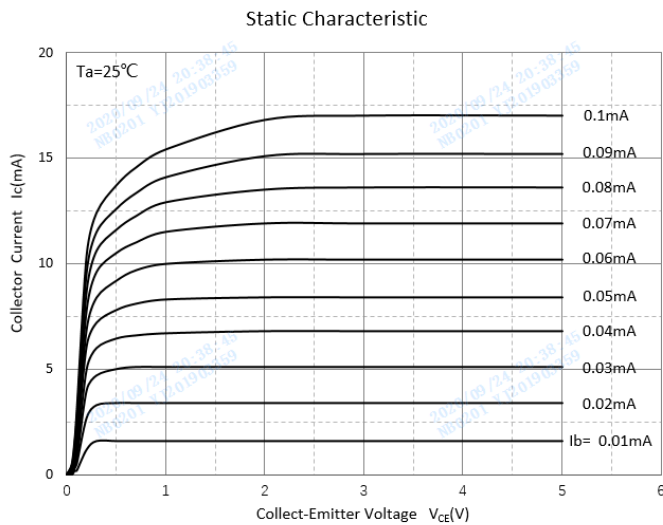



### Collector-Emitter Saturation Voltage

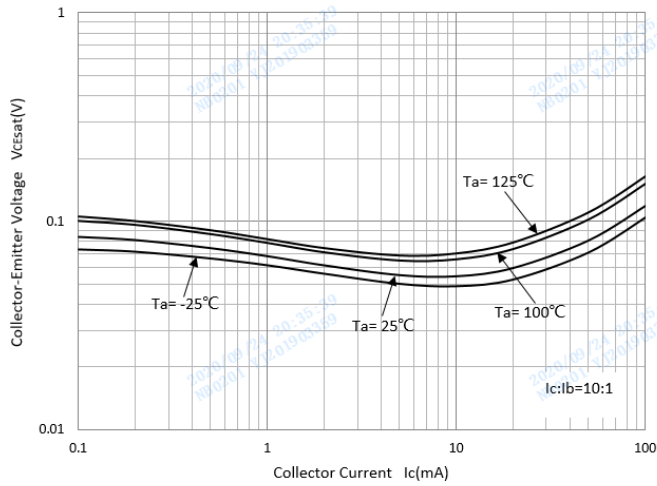

### Base-Emitter Saturation Voltage

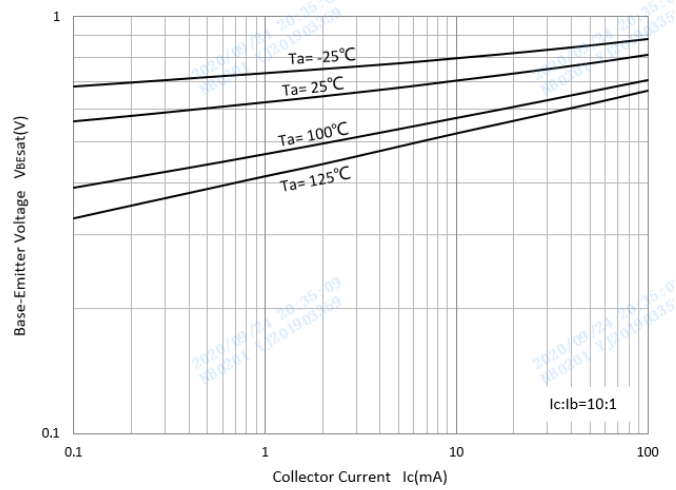

### Base-Emitter On Voltage

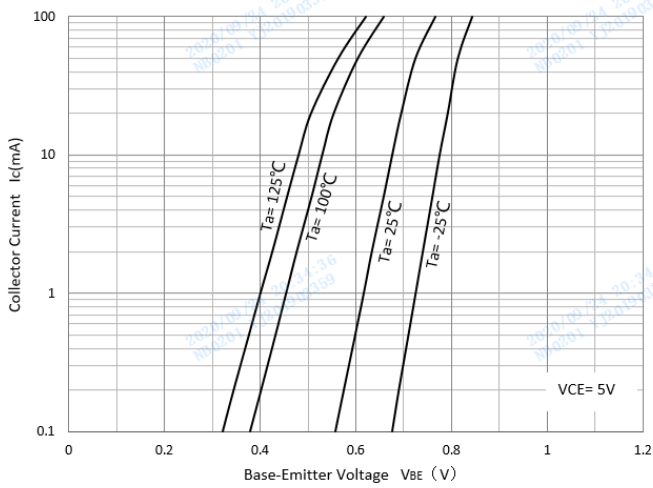

### $C_{ob}/C_{ib}-V_{CB}/V_{EB}$

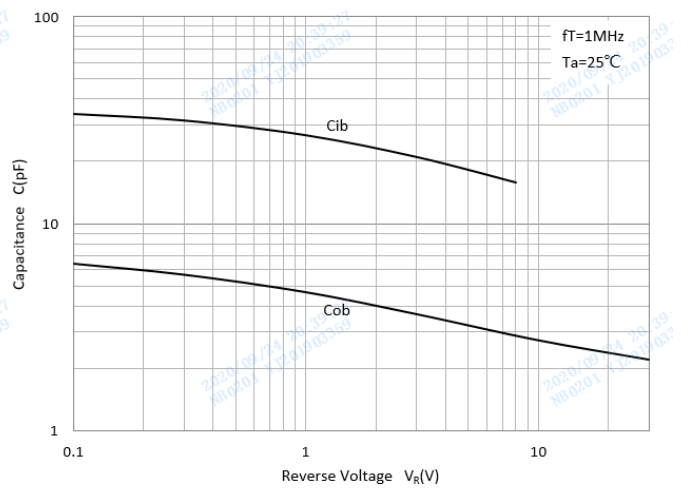

### Power Derating Curve

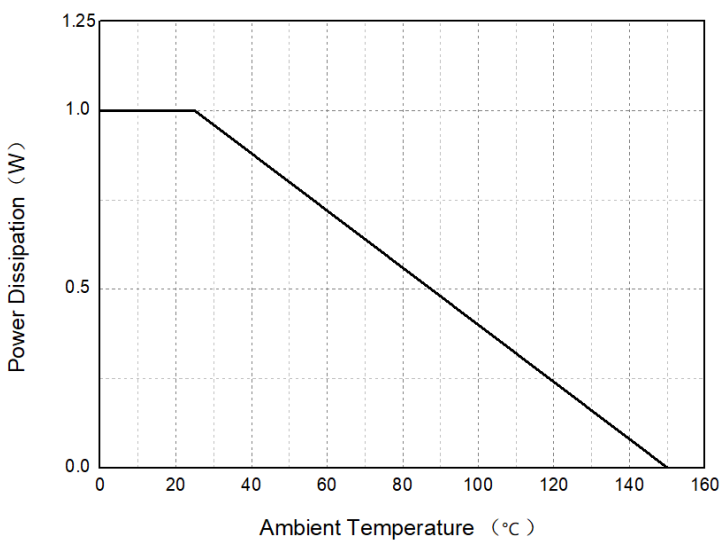



# CZT5551

## ■SOT-223 Package Outline Dimensions

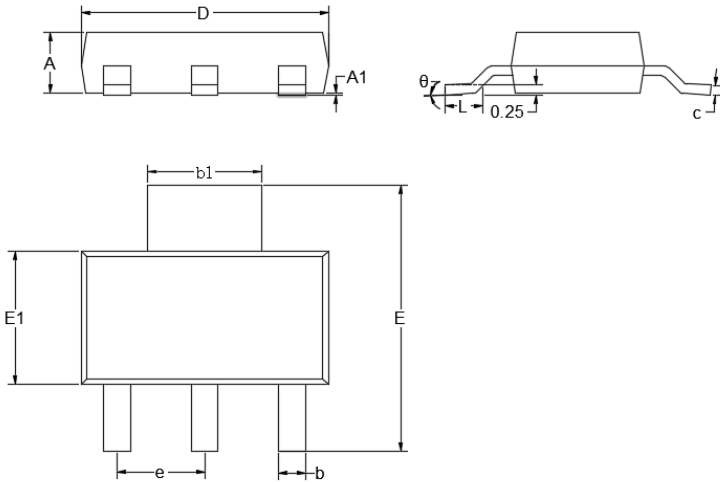

| DIMENSIONS |        |        |        |        |
|------------|--------|--------|--------|--------|
| DIM        | INCHES |        | MM     |        |
|            | MIN    | MAX    | MIN    | MAX    |
| A          | 0.0591 | 0.0670 | 1.5000 | 1.7000 |
| A1         | 0.0008 | 0.0039 | 0.0200 | 0.1000 |
| b          | 0.0259 | 0.0330 | 0.6600 | 0.8400 |
| b1         | 0.1140 | 0.1220 | 2.9000 | 3.1000 |
| c          | 0.0090 | 0.0138 | 0.2300 | 0.3500 |
| D          | 0.2480 | 0.2640 | 6.3000 | 6.7000 |
| E          | 0.2637 | 0.2874 | 6.7000 | 7.3000 |
| E1         | 0.1290 | 0.1460 | 3.3000 | 3.7000 |
| e          | 0.0866 | 0.0945 | 2.2000 | 2.4000 |
| L          | 0.0295 | 0.0492 | 0.7500 | 1.2500 |
| $\theta$   | 0°     | 10°    | 0°     | 10°    |

## ■SOT-223 Suggested Pad Layout

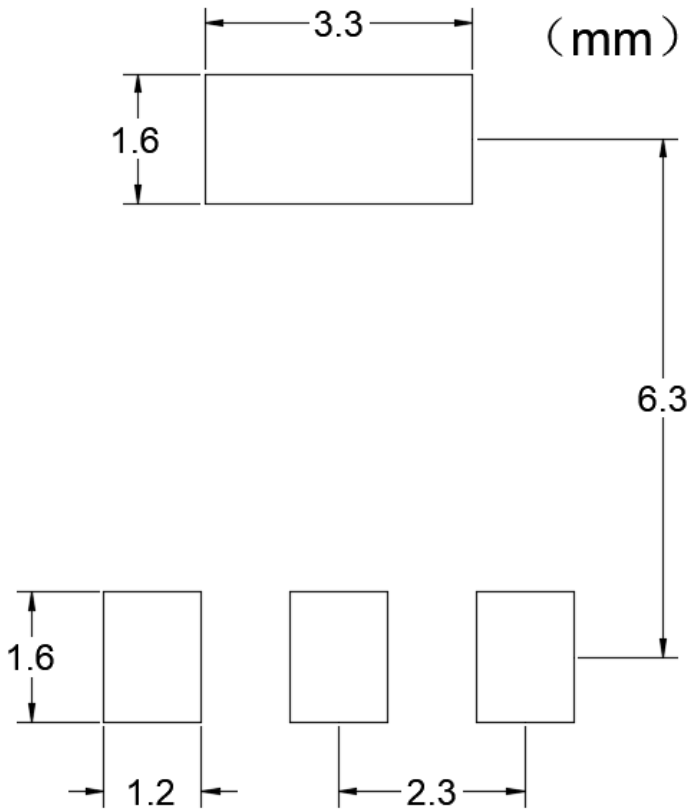



## Disclaimer

The information presented in this document is for reference only. Yangzhou Yangjie Electronic Technology Co., Ltd. reserves the right to make changes without notice for the specification of the products displayed herein to improve reliability, function or design or otherwise.

The product listed herein is designed to be used with ordinary electronic equipment or devices, and not designed to be used with equipment or devices which require high level of reliability and the malfunction of which would directly endanger human life (such as medical instruments, transportation equipment, aerospace machinery, nuclear-reactor controllers, fuel controllers and other safety devices), Yangjie or anyone on its behalf, assumes no responsibility or liability for any damages resulting from such improper use of sale.

This publication supersedes & replaces all information previously supplied. For additional information, please visit our website [http:// www.21yangjie.com](http://www.21yangjie.com) , or consult your nearest Yangjie's sales office for further assistance.