

PNP General Purpose Amplifier

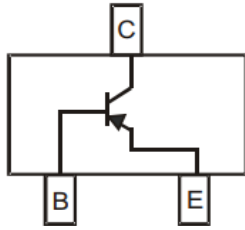

SOT-23

Features

- Epoxy meets UL-94 V-0 flammability rating and halogen free
- Moisture Sensitivity Level 1
- High Conductance
- Low $V_{CE(sat)}$
- Part no. with suffix "Q" means AEC-Q101 qualified

Applications

- PNP General Purpose Amplifier

Mechanical Data

- Case: SOT-23
- Terminals: Tin plated leads, solderable per J-STD-002 and JESD22-B102
- Marking: AKR

■ Maximum Ratings (Ta=25°C unless otherwise noted)

Item	Symbol	Unit	Value
Collector-Base Voltage	V_{CBO}	V	-80
Collector-Emitter Voltage	V_{CEO}	V	-80
Emitter-Base Voltage	V_{EBO}	V	-5
Collector Current -Continuous	I_C	mA	-500
Total Device Dissipation	P_D	mW	200
Junction Temperature	T_j	°C	-55 to +150
Storage Temperature	T_{STG}	°C	-55 to +150

■ Electrical Characteristics (Ta=25°C unless otherwise noted)

Item	Symbol	Unit	Conditions	Min	Typ	Max
Collector-base breakdown voltage	V_{CBO}	V	$I_C = -50\mu A, I_E = 0$	-80		
Collector-emitter breakdown voltage	V_{CEO}	V	$I_C = -2mA, I_B = 0$	-80		
Emitter-base breakdown voltage	V_{EBO}	V	$I_E = -50\mu A, I_C = 0$	-5		
Collector-base cut-off current	I_{CBO}	μA	$V_{CB} = -50V, I_E = 0$			-0.5
Emitter-base cut-off current	I_{EBO}	μA	$V_{EB} = -4V, I_C = 0$			-0.5
DC current gain	h_{FE}		$V_{CE} = -3V, I_C = -100mA$	180		390
Collector-emitter saturation voltage	$V_{CE(sat)}$	V	$I_C = -500mA, I_B = -50mA$			-0.5
Base-emitter saturation voltage	$V_{BE(sat)}$	V	$I_C = -500mA, I_B = -50mA$			-1.2



Other Characteristics (Ta=25°C unless otherwise noted)

Item	Symbol	Unit	Conditions	Min	Typ	Max
Transition frequency	f_T	MHz	$V_{CE}=-10V, I_C=-50mA, f=100MHz$		180	

Ordering Information (Example)

PREFERRED P/N	PACKING CODE	UNIT WEIGHT(g)	MINIMUM PACKAGE(pcs)	INNER BOX QUANTITY(pcs)	OUTER CARTON QUANTITY(pcs)	DELIVERY MODE
2SB1198-RQ	F2	Approximate 0.01	3000	30000	120000	7" reel

Characteristics(Typical)

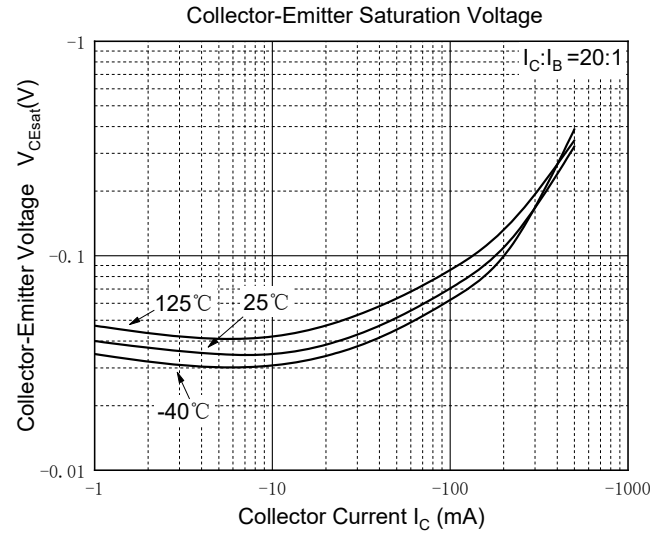
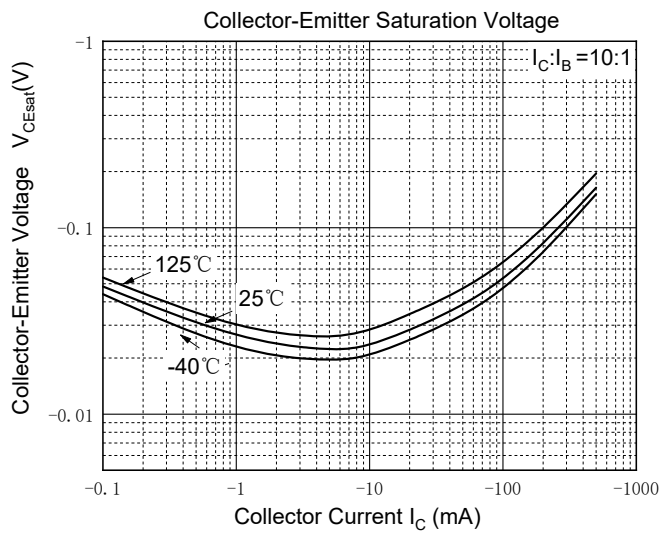
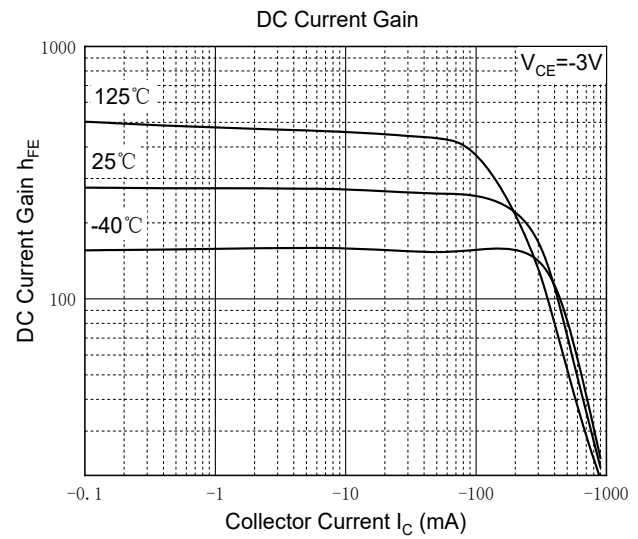
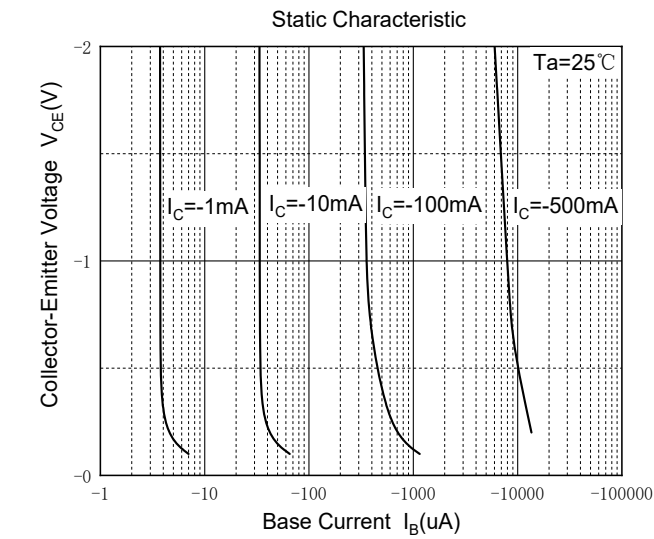



Collector-Emitter Saturation Voltage

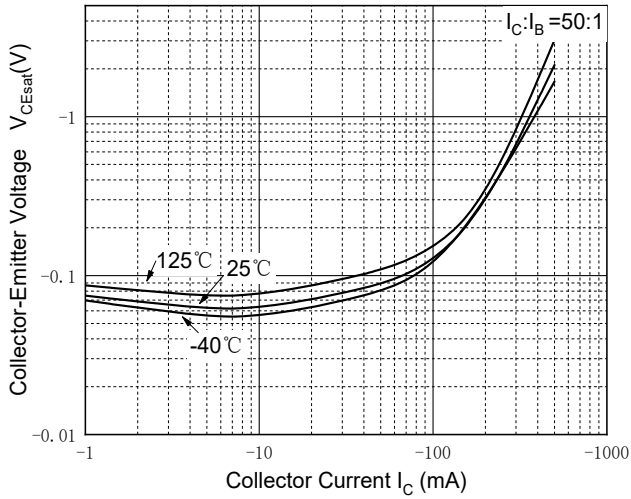

Base-Emitter Saturation Voltage

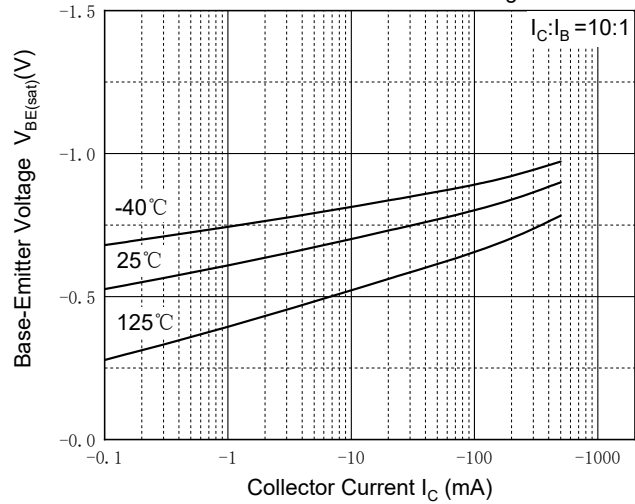

$C_{IB}/C_{OB} - V_{EB}/V_{CB}$

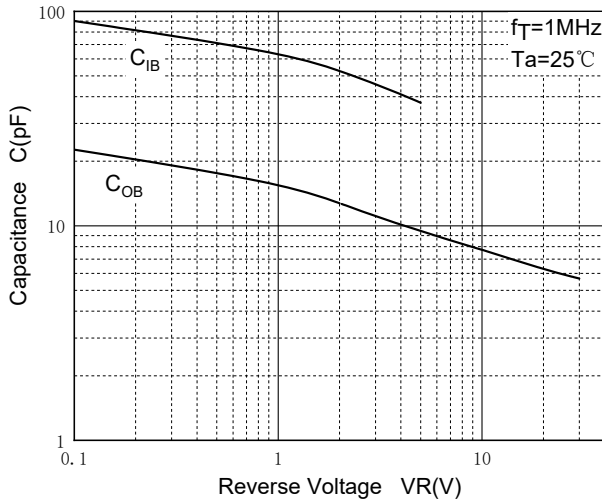

■ SOT-23 Package Outline Dimensions

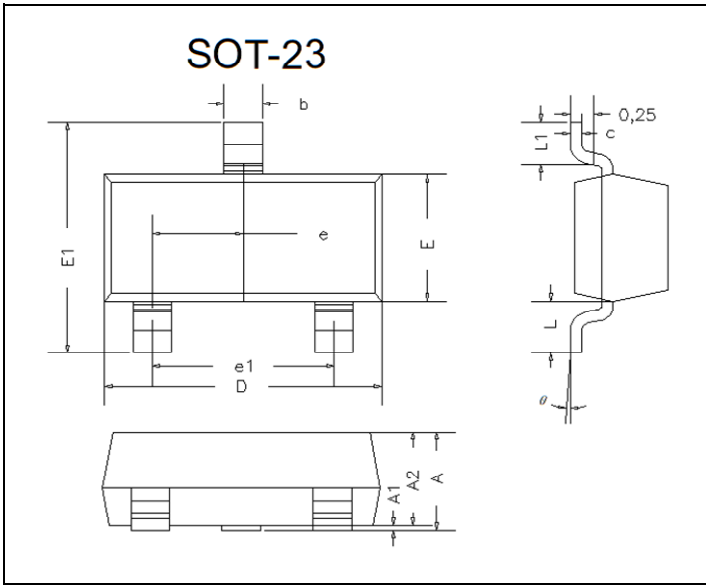

DIM	INCHES		MM		NOTE
	MIN	MAX	MIN	MAX	
A	0.035	0.045	0.90	1.15	
A1	0.000	0.004	0.00	0.10	
A2	0.035	0.041	0.90	1.05	
b	0.012	0.020	0.30	0.50	
c	0.004	0.008	0.10	0.20	
D	0.110	0.118	2.80	3.00	
E	0.047	0.055	1.20	1.40	
E1	0.089	0.100	2.25	2.55	
e	0.370TYP		0.95TYP		
e1	0.071	0.079	1.80	2.00	
L	0.220REF		0.55REF		
L1	0.012	0.020	0.30	0.50	
θ	0°	8°	0°	8°	

■ SOT-23 Suggested Pad Layout

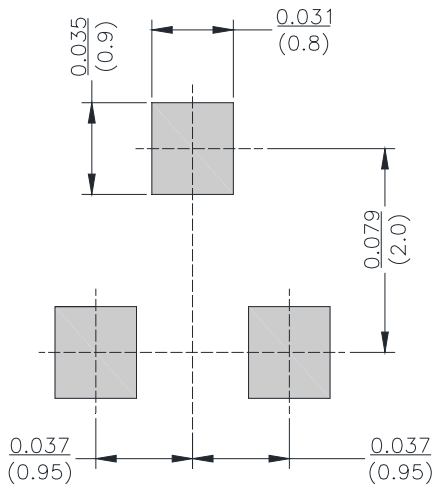

Unit: $\frac{\text{inch}}{\text{mm}}$



Disclaimer

The information presented in this document is for reference only. Yangzhou Yangjie Electronic Technology Co., Ltd. reserves the right to make changes without notice for the specification of the products displayed herein to improve reliability, function or design or otherwise.

The product listed herein is designed to be used with automotive electronics, are not designed for use in medical, life-saving, life-sustaining, or military. Yangjie or anyone on its behalf, assumes no responsibility or liability for any damages resulting from such improper use of sale.

This publication supersedes & replaces all information previously supplied. For additional information, please visit our website [http:// www.21yangjie.com](http://www.21yangjie.com) , or consult your nearest Yangjie's sales office for further assistance.