

High Speed Switching Diode



SOT-23

Features

- Epoxy meets UL-94 V-0 flammability rating and halogen free
- Moisture Sensitivity Level 1
- V_{BR} 100V
- I_{FAV} 200mA@ Single diode loaded
- Part no. with suffix "Q" means AEC-Q101 qualified

Applications

- Extreme fast switches
- Automotive

Mechanical Data

- **Case:** SOT-23
- **Terminals:** Tin plated leads, solderable per J-STD-002 and JESD22-B102

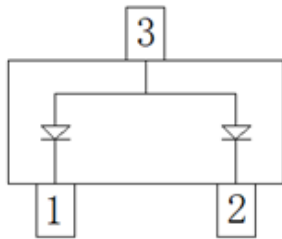

BAW56HQ
Marking: A1[⊗]

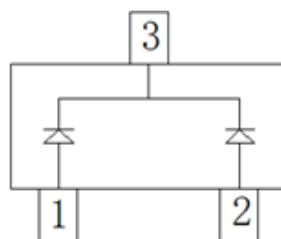

BAV70HQ
Marking: A4[⊗]

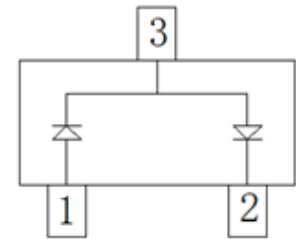

BAV99HQ
Marking: A7[⊗]

■ Maximum Ratings ($T_a=25^{\circ}\text{C}$ Unless otherwise specified)

PARAMETER	SYMBOL	UNIT	CONDITIONS	VALUE
Reverse Breakdown Voltage	V_{BR}	V		100
Average Forward Current	$I_{FAV[1]}$	mA		200
Non-Repetitive Peak Forward Surge Current	I_{FSM}	A	$t_p=1$ ms	1
Power Dissipation	$P_{tot[1]}$	mW		200
Thermal Resistance Junction to Ambient	R_{thJA}	$^{\circ}\text{C}/\text{W}$		625
Maximum Junction Temperature	T_j	$^{\circ}\text{C}$		-55 to +150
Storage Temperature Range	T_{stg}	$^{\circ}\text{C}$		-55 to +150

[1] Single diode loaded



BAW56HQ&BAV70HQ&BAV99HQ

■ Electrical Characteristics (T_a=25°C Unless otherwise specified)

PARAMETER	SYMBOL	UNIT	CONDITIONS	MIN	Typ	MAX
Forward Voltage	V _F	V	I _F =1mA			0.715
			I _F =10mA			0.855
			I _F =50mA			1.0
			I _F =150mA			1.25
Reverse Current	I _R	μA	V _R =75V			1
Reverse Breakdown Voltage	V _{BR}	V	I _R =10μA	100		
Junction Capacitance	C _j	pF	V _R =V _F =0V, f=1MHz			4
Reverse Recovery Time	t _{rr}	ns	I _F =10mA, I _{rr} =0.1I _R , R _L =100Ω			5

■ Ordering Information (Example)

PREFERRED P/N	PACKING CODE	UNIT WEIGHT(g)	MINIMUM PACKAGE(pcs)	INNER BOX QUANTITY(pcs)	OUTER CARTON QUANTITY(pcs)	DELIVERY MODE
BAW56HQ BAV70HQ BAV99HQ	F2	Approximate 0.010	3000	30000	120000	7" reel



BAW56HQ&BAV70HQ&BAV99HQ

■ Characteristics (Typical)

Fig.1: $P_D - T_A$

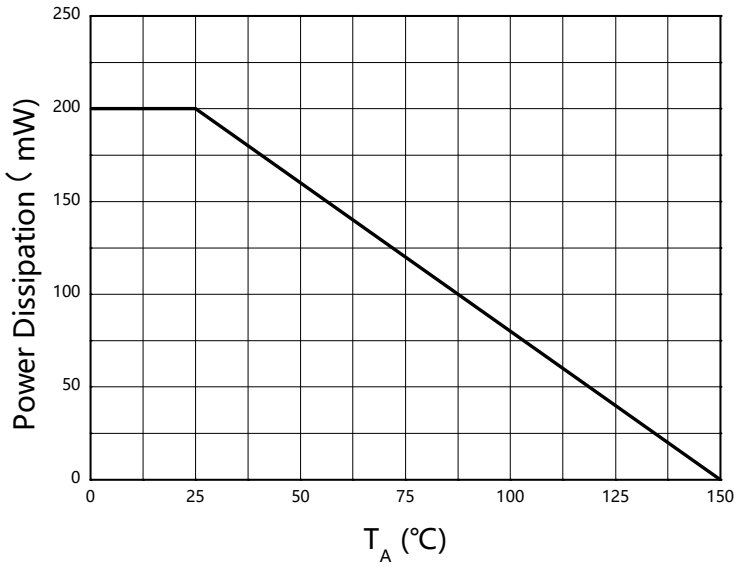

Fig.2: Capacitance Characteristics

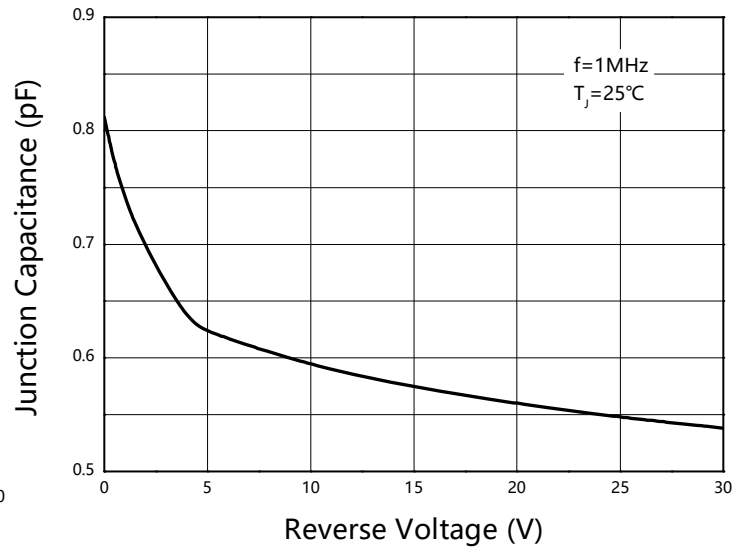

Fig.3: Forward Characteristics

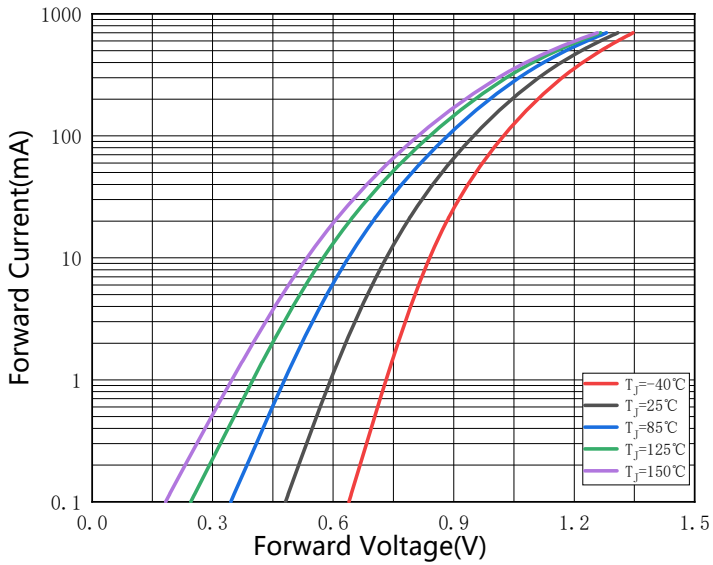
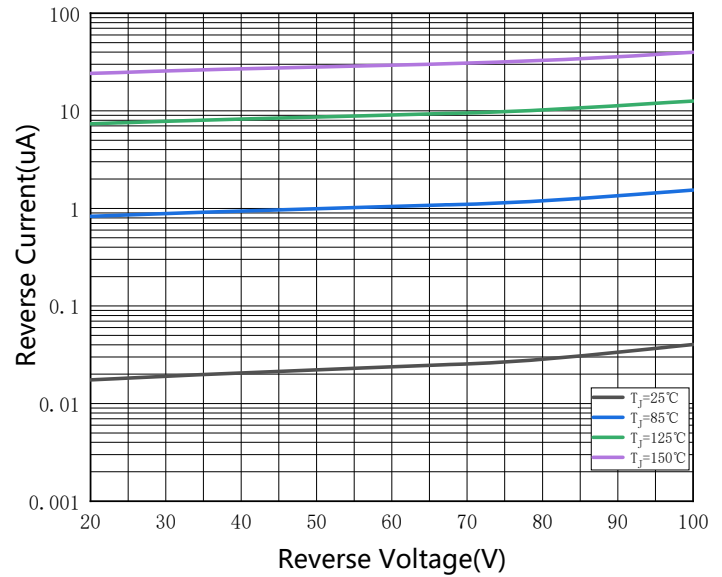

Fig.4: Reverse Characteristics





BAW56HQ&BAV70HQ&BAV99HQ

■ Outline Dimensions

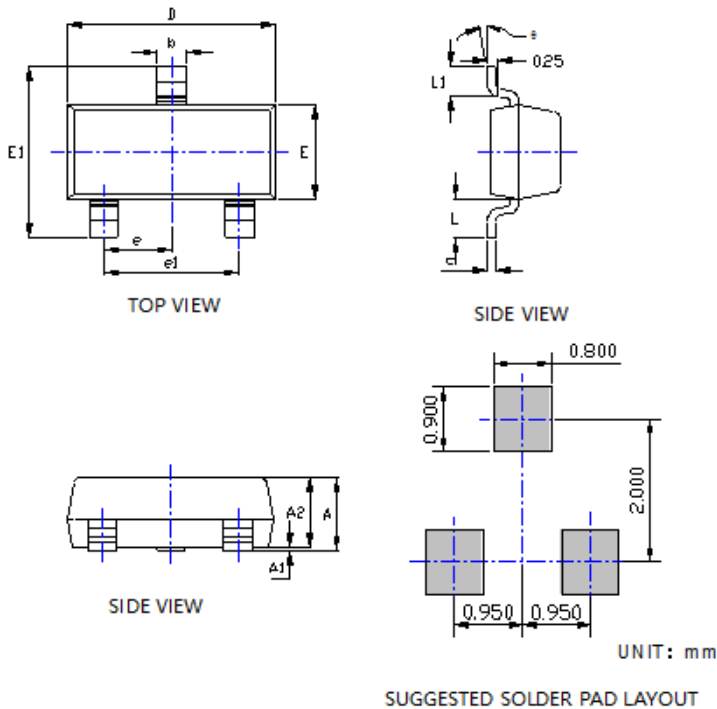

SYMBOL	DIMENSIONS			
	INCHES		Millimeter	
	MIN.	MAX.	MIN.	MAX.
A	0.035	0.045	0.900	1.150
A1	0.000	0.004	0.000	0.100
A2	0.035	0.041	0.900	1.050
b	0.012	0.020	0.300	0.500
c	0.004	0.008	0.100	0.200
D	0.110	0.118	2.800	3.000
E	0.047	0.055	1.200	1.400
E1	0.089	0.100	2.250	2.550
e	0.037TYP		0.950TYP	
e1	0.071	0.079	1.800	2.000
L	0.022REF		0.550REF	
L1	0.012	0.020	0.300	0.500
φ	0°	8°	0°	8°

NOTE:
 1. PACKAGE BODY SIZES EXCLUDE MOLD FLASH AND GATE BURRS.
 2. TOLERANCE 0.1mm UNLESS OTHERWISE SPECIFIED.
 3. THE PAD LAYOUT IS FOR REFERENCE PURPOSES ONLY.

■ Marking Information

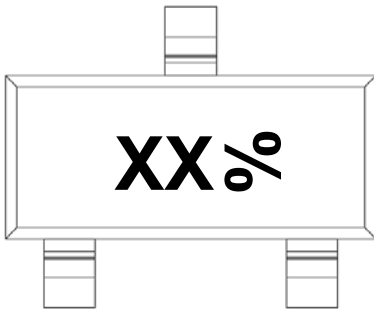

PN	Marking Code
BAW56HQ	A1
BAV70HQ	A4
BAV99HQ	A7

Note:

1. All marking is at middle of the product body
2. All marking is in laser marking
3. Body color: Black
4. XX is Marking Code
5. % is a date code, rotated 90° counterclockwise

*Date Code vary depending upon production date



Disclaimer

The information presented in this document is for reference only. Yangzhou Yangjie Electronic Technology Co., Ltd. reserves the right to make changes without notice for the specification of the products displayed herein to improve reliability, function or design or otherwise.

The product listed herein is designed to be used with automotive electronics, are not designed for use in medical, life-saving, life-sustaining, or military, Yangjie or anyone on its behalf, assumes no responsibility or liability for any damages resulting from such improper use of sale.

This publication supersedes & replaces all information previously supplied. For additional information, please visit our website [http:// www.21yangjie.com](http://www.21yangjie.com) , or consult your nearest Yangjie's sales office for further assistance.