



## Glass Passivated Three Phase Rectifier Bridge

**VRRM** 800 to 1800V  
**ID** 250 A

### Applications

- Three phase rectifiers for power supplies
- Rectifiers for DC motor field supplies
- Battery charger rectifiers
- Input rectifiers for variable frequency drives

### Features

- Three phase bridge rectifier
- Blocking voltage:800 to 1800V
- Heat transfer through aluminum oxide DBC ceramic isolated metal baseplate
- Glass passivated chip
- UL recognized applied for file no. E360040

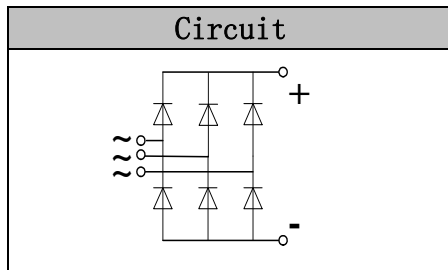

### Module Type

TYPE	VRRM	VRSM
MD250S08M5	800V	900V
MD250S12M5	1200V	1300V
MD250S16M5	1600V	1700V
MD250S18M5	1800V	1900V

### Maximum Ratings

Symbol	Conditions	Values	Units
ID	Three phase, full wave Tc=100°C	250	A
IFSM	t=10mS Tvj =45°C	2500	A
i <sup>2</sup> t	t=10mS Tvj =45°C	31250	A <sup>2</sup> s
Visol	a.c.50HZ;r.m.s.;1min	3000	V
Tvj		-40 to +150	°C
Tstg		-40 to +125	°C
Mt	To terminals (M6)	5±15%	Nm
Ms	To heatsink (M6)	5±15%	Nm
Weight	Module (Approximately)	194	g

### Thermal Characteristics

Symbol	Conditions	Values	Units
Rth(j-c)	Per diode	0.36	°C/W
Rth(c-s)	Module (Approximately)	0.02	°C/W

### Electrical Characteristics

Symbol	Conditions	Values			Units
		Min.	Typ.	Max.	
VFM	T=25°C IF =300A	—	1.40	1.60	V
IRD	Tvj=25°C VRD=VRRM	—	—	0.5	mA
	Tvj=150°C VRD=VRRM	—	—	6	mA

## Performance Curves

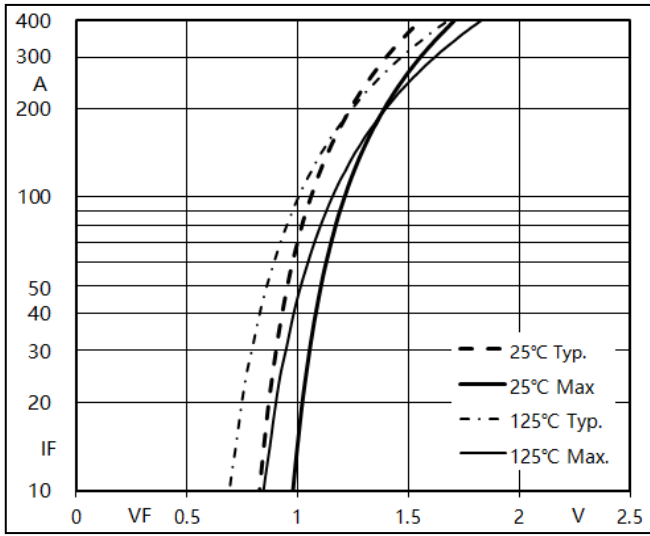

**Fig1. Forward Characteristics**

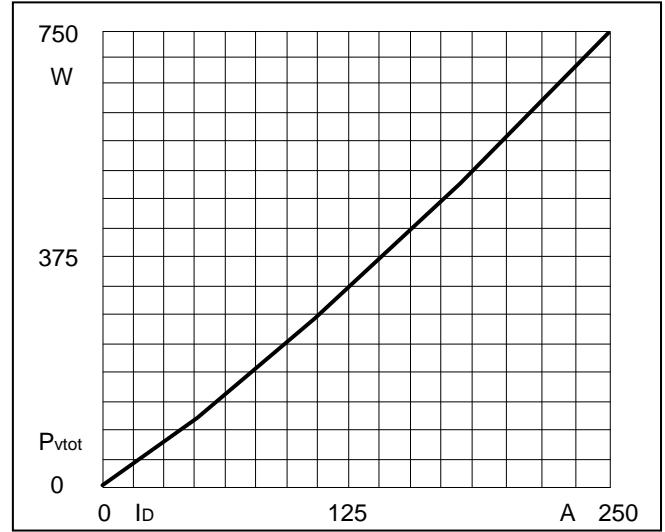

**Fig2. Power dissipation**

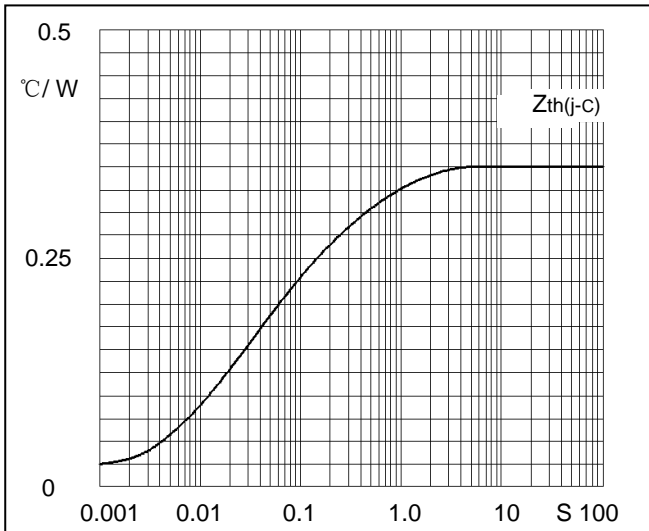

**Fig3. Transient thermal impedance**

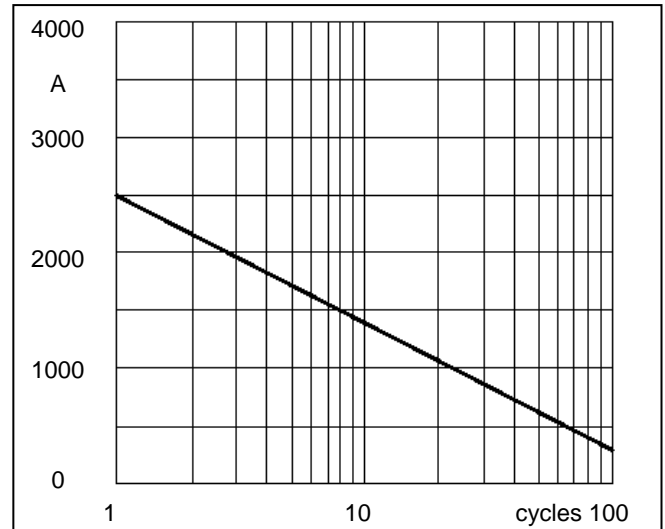

**Fig4. Max Non-Repetitive Forward Surge Current**

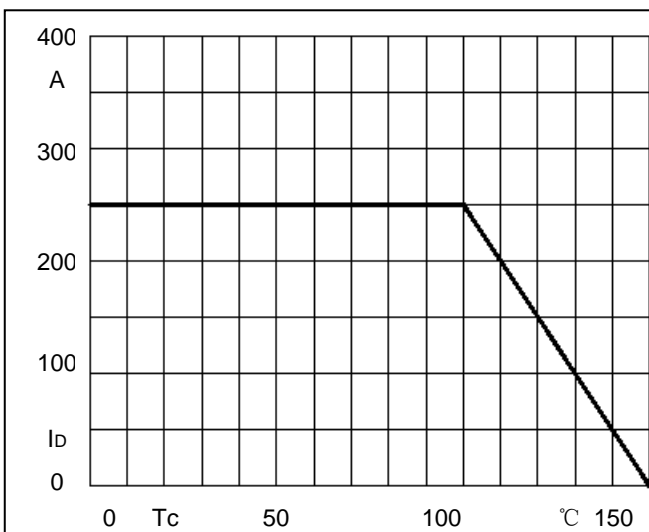

**Fig5. Forward Current Derating Curve**

## Package Outline Information

CASE:M5

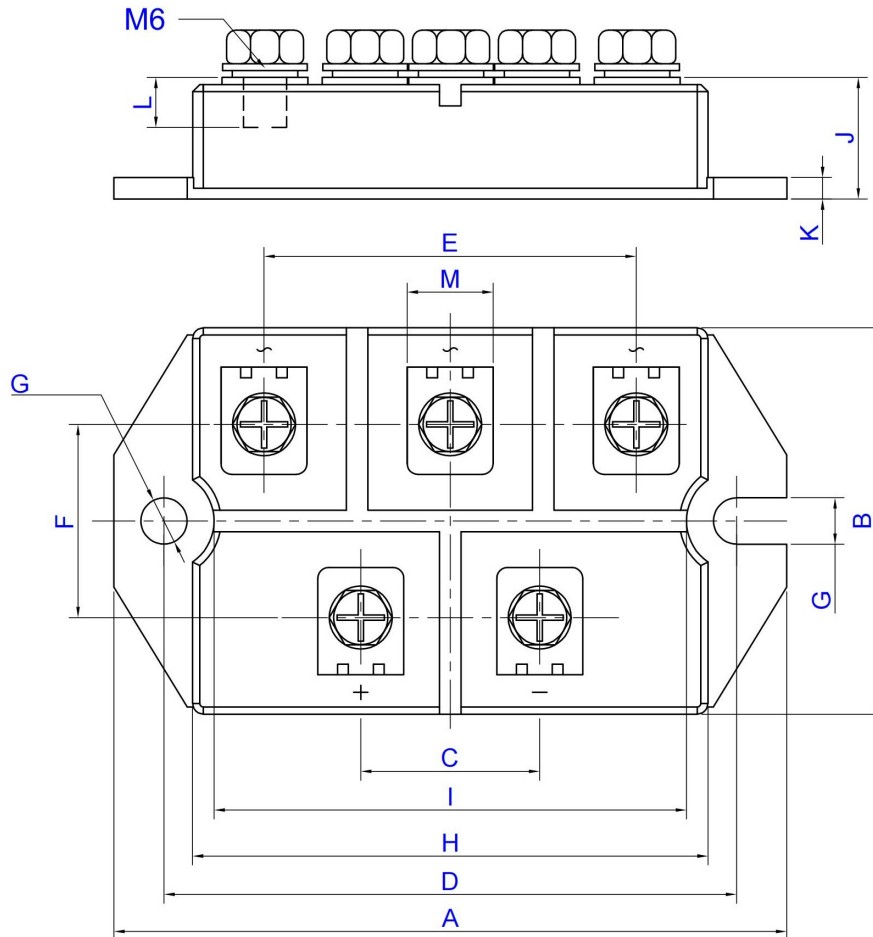

DIM	Min (mm)	Max (mm)	Note
A	93.5	94.5	
B	53.5	54.5	
C	24.5	25.5	
D	79.5	80.5	
E	51.5	52.5	
F	26.5	27.5	
G	6.2	6.8	∅
H	71.5	72.5	
I	65.5	66.5	
J	16.5	17.5	
K	2.9	3.1	
L	6.5	7.5	
M	11.9	12.1	

## Packing Standard

Item	Length: A (mm)	Width: B (mm)	Height: C (mm)	Quantity (PCS)
Inner Box	276	258	48	6
Outer Carton	545	295	240	60



### **Disclaimer**

The information presented in this document is for reference only. Yangzhou Yangjie Electronic Technology Co., Ltd. reserves the right to make changes without notice for the specification of the products displayed herein to improve reliability, function or design or otherwise.

The product listed herein is designed to be used with automotive electronics, are not designed for use in medical, life-saving, lifesustaining, or military, Yangjie or anyone on its behalf, assumes no responsibility or liability for any damages resulting from such improper use of sale.

This publication supersedes & replaces all information previously supplied. For additional information, please visit our website <http://www.21yangjie.com>, or consult your nearest Yangjie's sales office for further assistance.