



Glass Passivated Rectifier Diode Modules

VRRM 800 to 1800V
IFAV 165 A

Applications

- Non-controllable rectifiers for AC/AC converters
- Line rectifiers for transistorized AC motor controllers
- Field supply for DC motors
- PV combiner box

Features

- Blocking voltage:800 to 1800V
- Heat transfer through aluminum oxide DBC ceramic isolated metal baseplate
- Glass passivated chip

Circuit

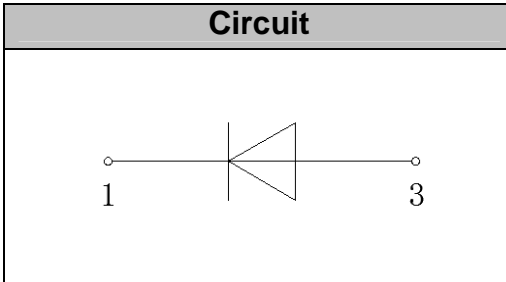

Module Type

TYPE	VRRM	VRSM
MD165U08D2	800V	900V
MD165U12D2	1200V	1300V
MD165U16D2	1600V	1700V
MD165U18D2	1800V	1900V

Maximum Ratings

Symbol	Conditions	Values	Units
IFAV	Single phase ,half wave 180° conduction Tc=101°C	165	A
IFSM	t=10mS Tvj =45°C	6000	A
i ² t	t=10mS Tvj =45°C	180000	A ² s
V _{isol}	a.c.50HZ;r.m.s.;1min	3000	V
T _{vj}		-40 to +150	°C
T _{stg}		-40 to +125	°C
Mt	To terminals(M6)	5±15%	Nm
Ms	To heatsink(M6)	5±15%	Nm
Weight	Module (Approximately)	160	g

Thermal Characteristics

Symbol	Conditions	Values	Units
R _{th(j-c)}	Per diode	0.21	°C/W
R _{th(c-s)}	Module	0.05	°C/W

Electrical Characteristics

Symbol	Conditions	Values			Units
		Min.	Typ.	Max.	
V _{FM}	T=25°C IF =300A	—	1.10	1.20	V
I _{RD}	Tvj=150°C VRD=VRRM	—	—	9	mA



Performance Curves

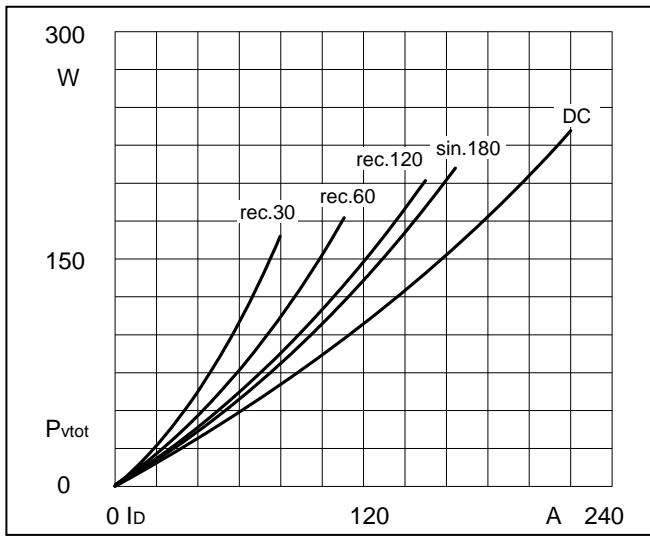

Fig1. Power dissipation

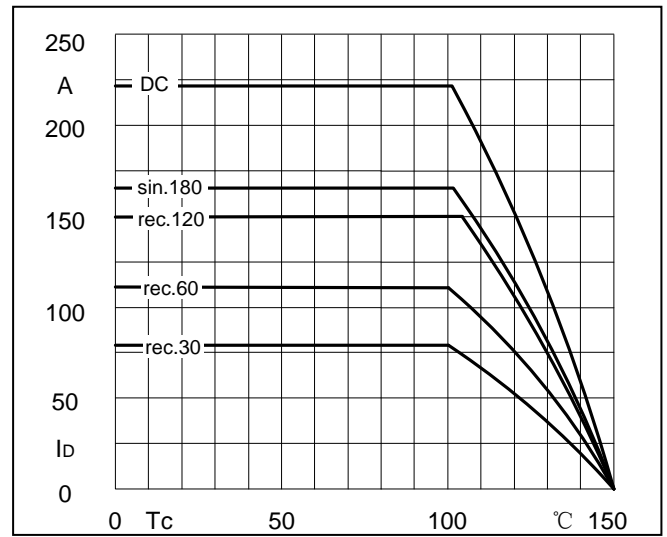

Fig2. Forward Current Derating Curve

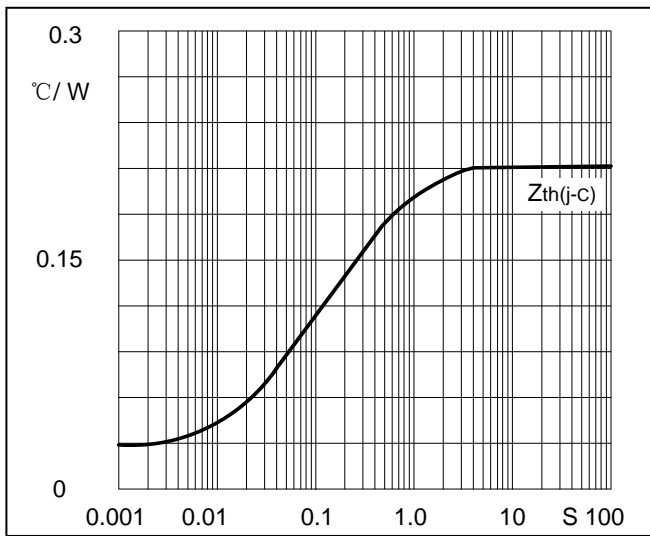

Fig3. Transient thermal impedance

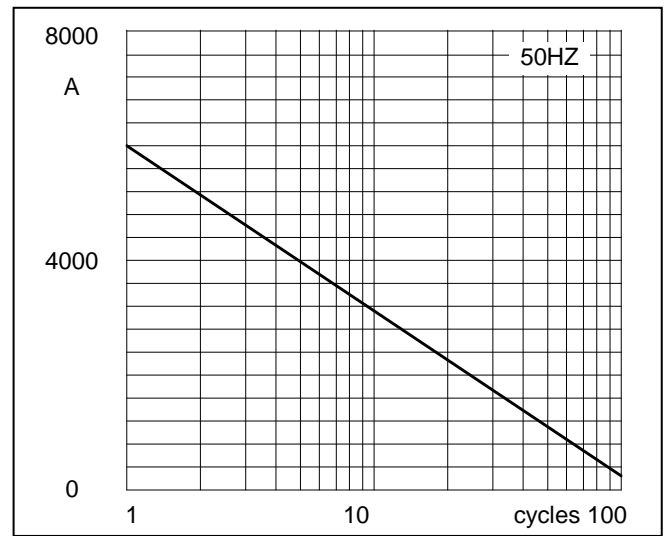

Fig4. Max Non-Repetitive Forward Surge Current

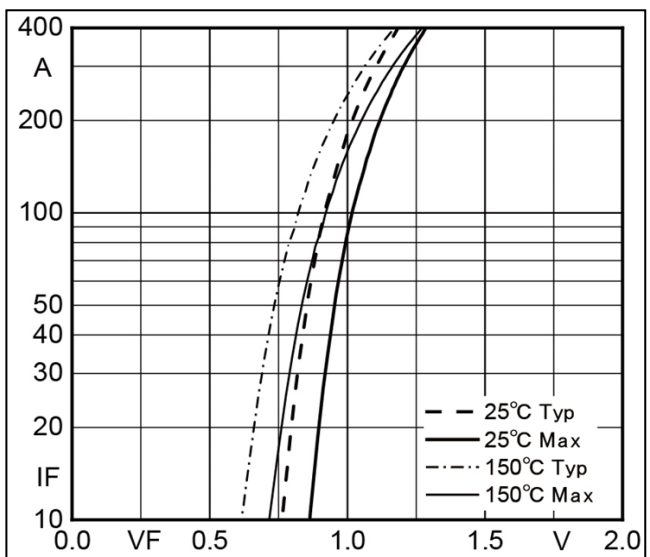
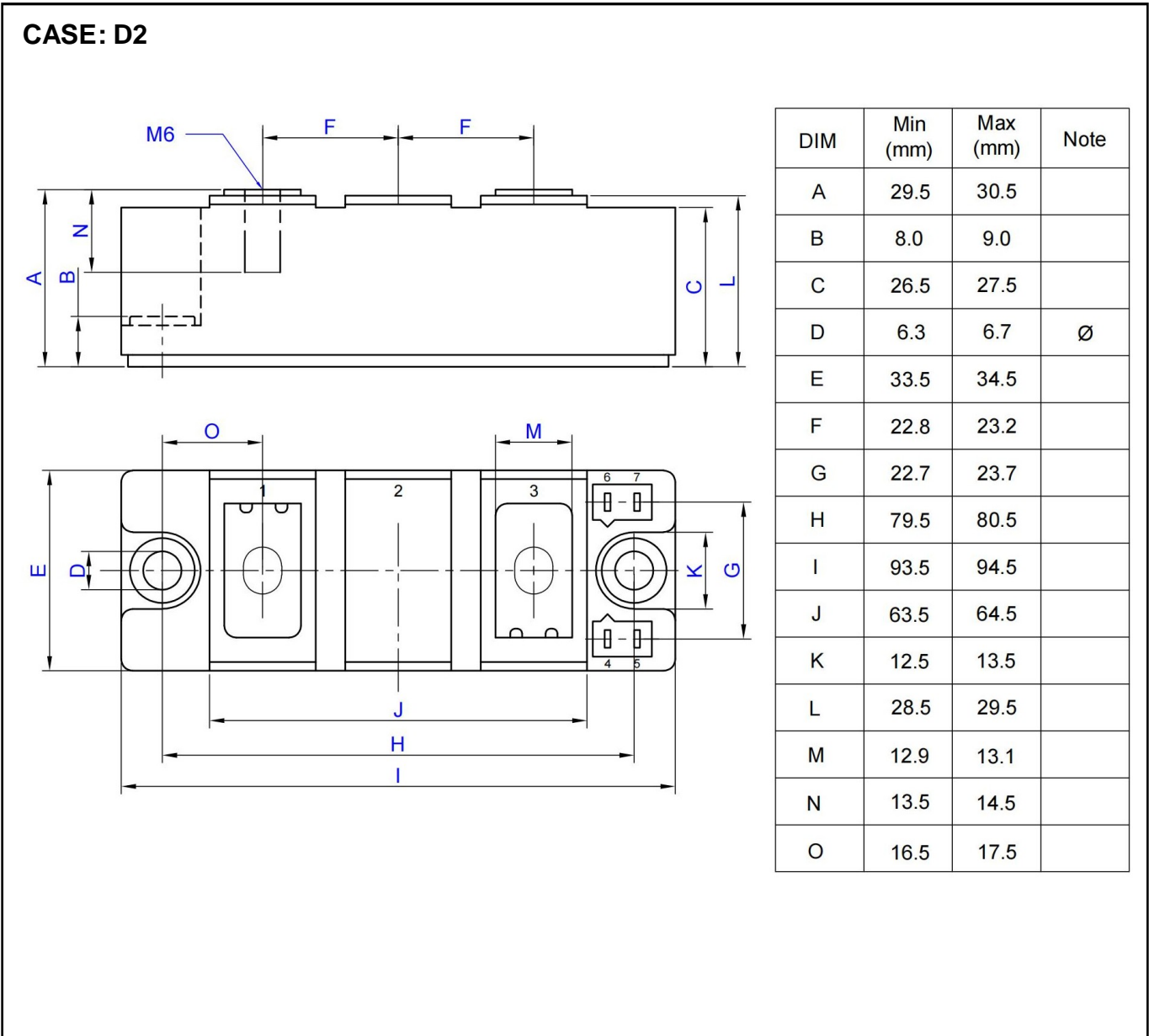

Fig5. Forward Characteristics

Package Outline Information



Packing Standard

Item	Length: A (mm)	Width: B (mm)	Height: C (mm)	Quantity (PCS)
Inner Box	276	258	48	8
Outer Carton	545	295	240	80



Disclaimer

The information presented in this document is for reference only. Yangzhou Yangjie Electronic Technology Co., Ltd. reserves the right to make changes without notice for the specification of the products displayed herein to improve reliability, function or design or otherwise.

The product listed herein is designed to be used with automotive electronics, are not designed for use in medical, life-saving, lifesustaining, or military, Yangjie or anyone on its behalf, assumes no responsibility or liability for any damages resulting from such improper use of sale.

This publication supersedes & replaces all information previously supplied. For additional information, please visit our website <http://www.21yangjie.com>, or consult your nearest Yangjie's sales office for further assistance.