

N-Channel Enhancement Mode Mosfet

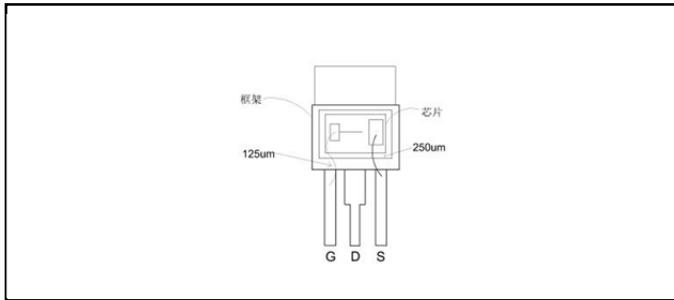
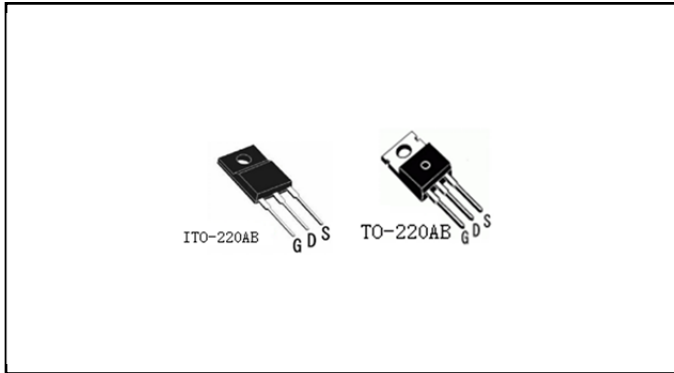

Feature:

- Low Crss
- Low Gate Charge
- Fast Switching
- Improved ESD Capability
- Improved dv/dt Capability
- 100% Avalanche Energy Test

Mechanical Data:

- **Package: MOS**
Molding compound meets UL 94 V-0 flammability rating, RoHS-compliant
- **Terminal: Tin plated leads.**
Solderable per J-STD-002 and JESD22-B102
- **Polarity:** As marked on body

■ Ordering Information

P/N	PACKAGE	PACKING CODE	UNIT WEIGHT(g)	MINIIMUM PACKAGE(pcs)	INNER BOX QUANTITY(pcs)	OUTER CARTON QUANTITY(pcs)	DELIVERY MODE
YJ7N80CI	ITO-220AB	B1	Approximate 1.7	50	1000	5000	TUBE
YJ7N80CZ	TO-220AB	B1	Approximate 1.6	50	1000	5000	TUBE
YJ7N80CM	TO-263	B1	Approximate 2.0	50	1000	5000	TUBE

■ Maximum Ratings ($T_a=25^{\circ}\text{C}$ Unless otherwise specified)

Parameter	Symbol	Value	Unit
Drain-Source Voltage	V_{DSS}	800	V
Continues Drain Current	I_D	$T_c=25^{\circ}\text{C}$	7*
		$T_c=100^{\circ}\text{C}$	4.0*
Plused Drain Current (note 1)	I_{DM}	28	A
Gate-to-Source Voltage	V_{GS}	± 30	V
Single Pulsed Avalanche Energy (note 2)	E_{AS}	418	mJ
Avalanche Current (note 1)	I_{AR}	7.0	A
Repetitive Avalanche Energy (note 1)	E_{AR}	18	mJ
Peak Diode Recovery (note 3)	dv/dt	4.5	V/ns
Power Dissipation	P_D $T_c=25^{\circ}\text{C}$	TO-220AB	140
		ITO-220AB	49
Power Dissipation Derating Factor	$P_{D(DF)}$ Above 25°C	TO-220AB	1.12
		ITO-220AB	0.39
Operating and Storage Temperature Range	T_J, T_{STG}	150, $-55 \sim +150$	$^{\circ}\text{C}$
Maximum Temperature for Soldering	T_L	300	$^{\circ}\text{C}$

■ Electrical Characteristics ($T_a=25^{\circ}\text{C}$ Unless otherwise specified)

Off-Characteristics						
Parameter	Symbol	Tests Conditions	Min	Type	Max	Unit
Drain-Source Breakdown Voltage	BV_{DSS}	$I_D=250\mu\text{A}, V_{GS}=0\text{V}$	800	-	-	V
Breakdown Voltage Temperature Coefficient	$\Delta BV_{DSS}/\Delta T_J$	$I_D=250\mu\text{A}$, referenced to 25°C	-	0.7	-	$\text{V}/^{\circ}\text{C}$
Zero Gate Voltage Drain Current	I_{DSS}	$V_{DS}=800\text{V}, V_{GS}=0\text{V}, T_c=25^{\circ}\text{C}$	-	-	10	μA
		$V_{DS}=640\text{V}, T_c=125^{\circ}\text{C}$	-	-	100	
Gate-body leakage current, forward	I_{GSSF}	$V_{DS}=0\text{V}, V_{GS}=30\text{V}$	-	-	100	nA
Gate-body leakage current, reverse	I_{GSSR}	$V_{DS}=0\text{V}, V_{GS}=-30\text{V}$	-	-	-100	nA



On-Characteristics						
Parameter	Symbol	Tests Conditions	Min	Type	Max	Unit
Gate Threshold Voltage	$V_{GS(th)}$	$V_{DS} = V_{GS}, I_D=250\mu A$	2.0	-	4.0	V
Static Drain-Source On-Resistance	$R_{DS(ON)}$	$V_{GS}=10V, I_D=3.5A$	-	1.6	2.0	Ω
Forward Transconductance	g_{fs}	$V_{DS} = 40V, I_D=3.5A$ (note4)	-	5.0	-	S

Dynamic Characteristics						
Parameter	Symbol	Tests Conditions	Min	Type	Max	Unit
Input capacitance	C_{iss}	$V_{DS}=25V, V_{GS}=0V, f=1.0MHz$	-	1300	1690	pF
Output capacitance	C_{oss}		-	125	160	pF
Reverse transfer capacitance	C_{rss}		-	12	15	pF

Switching Characteristics						
Parameter	Symbol	Tests Conditions	Min	Type	Max	Unit
Turn-On delay time	$t_d(on)$	$V_{DD}=400V, I_D=7A, R_G=25\Omega$ (note 4, 5)	-	35	80	ns
Turn-On rise time	t_r		-	100	210	ns
Turn-Off delay time	$t_d(off)$		-	50	110	ns
Turn-Off Fall time	t_f		-	60	130	ns
Total Gate Charge	Q_g	$V_{DS}=640V, I_D=7A, V_{GS}=10V$ (note 4, 5)	-	27	35	nC
Gate-Source charge	Q_{gs}		-	8.2	-	nC
Gate-Drain charge	Q_{gd}		-	11	-	nC

Drain-Source Diode Characteristics and Maximum Ratings						
Parameter	Symbol	Tests Conditions	Min	Type	Max	Unit
Maximum Continuous Drain-Source Diode Forward Current		I_S	-	-	7	A
Maximum Pulsed Drain-Source Diode Forward Current		I_{SM}	-	-	28	A
Drain-Source Diode Forward Voltage	V_{SD}	$V_{GS}=0V, I_S=7A$	-	-	1.4	V
Reverse recovery time	t_{rr}	$V_{GS}=0V, I_S=7A$ $di_F/dt=100A/\mu s$ (note 4)	-	650	-	ns
Reverse recovery charge	Q_{rr}		-	7.0	-	μC

■ Thermal Characteristics (T_a=25°C Unless otherwise specified)

Parameter	Symbol		Max	Unit
Thermal Resistance, Junction to Case	Rth(j-c)	TO-220AB	0.89	°C/W
		ITO-220AB	2.55	
Thermal Resistance, Junction to Ambient	Rth(j-A)	TO-220AB	62.5	°C/W
		ITO-220AB	62.5	

* Drain current limited by maximum junction temperature

Notes:

- 1: Pulse width limited by maximum junction temperature
- 2: L=11.5mH, I_{AS}=7A, V_{DD}=50V, R_G=25Ω, Starting T_J=25°C
- 3: I_{SD} ≤7A, di/dt ≤300A/μs, V_{DD} ≤BV_{DSS}, Starting T_J=25°C
- 4: Pulse Test: Pulse Width ≤300μs, Duty Cycle ≤2%
- 5: Essentially independent of operating temperature

■ Characteristics (Typical)

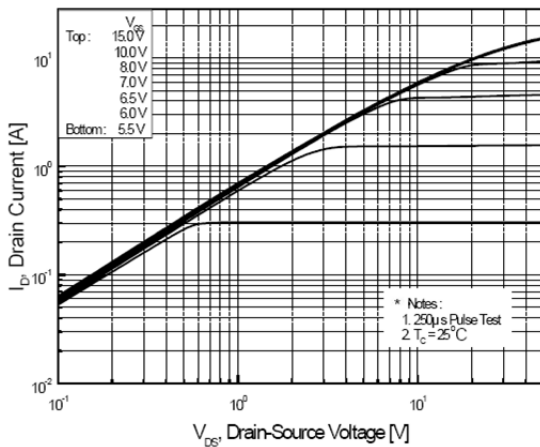

Fig. 1 On-State Characteristics

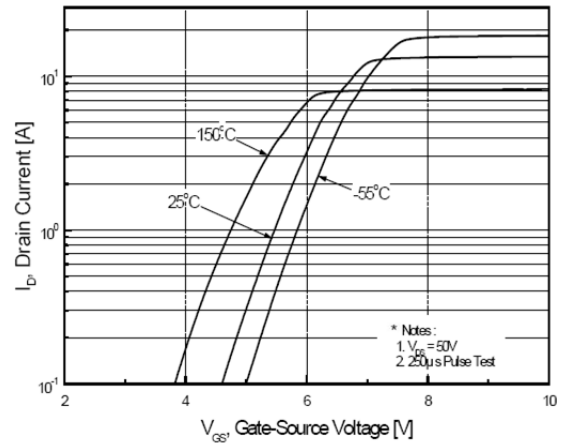

Fig. 2 Transfer Characteristics

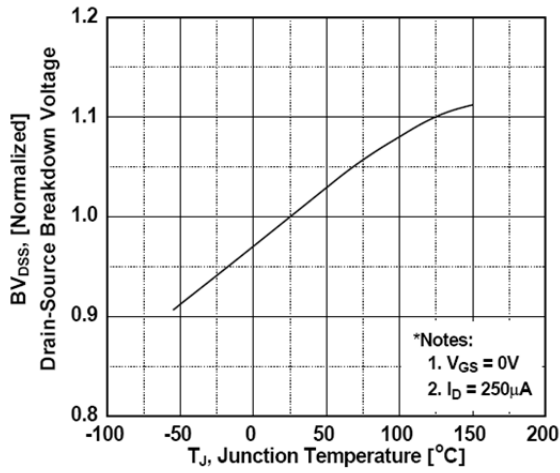

Fig. 3 Breakdown Voltage Variation vs Temperature

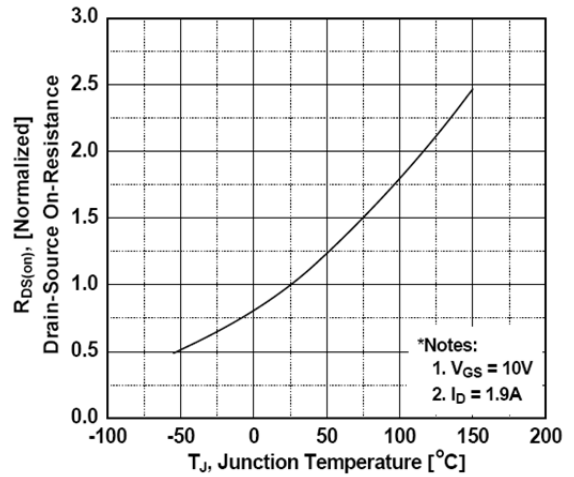

Fig. 4 On-Resistance Variation vs Temperature

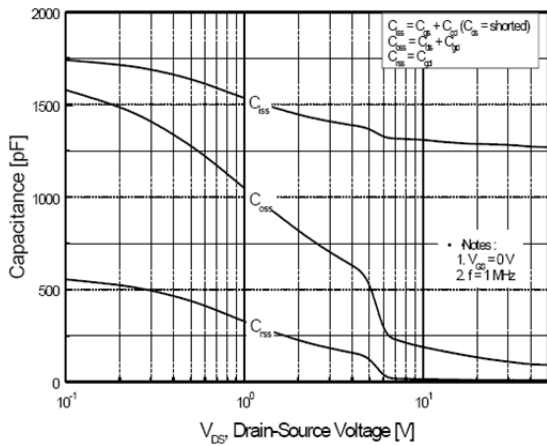

Fig. 5 Capacitance Characteristics

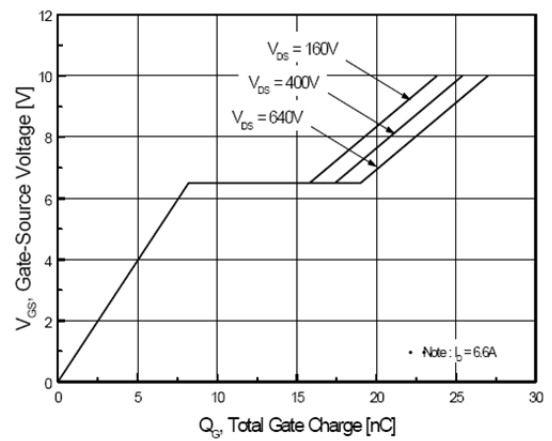

Fig. 6 Gate Charge Characteristics

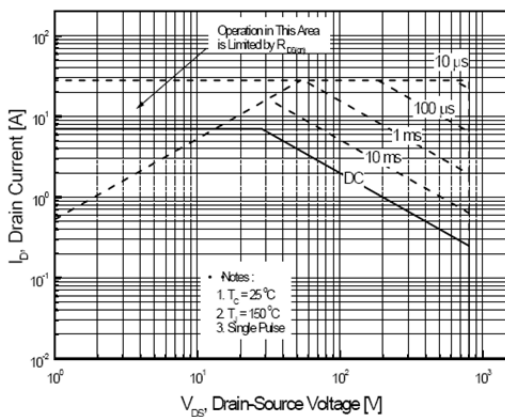

Fig. 7 Maximum Safe Operating Area

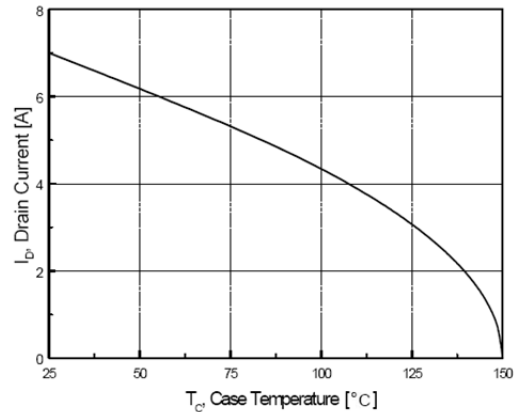

Fig. 8 Maximum Drain Current vs Case Temperature

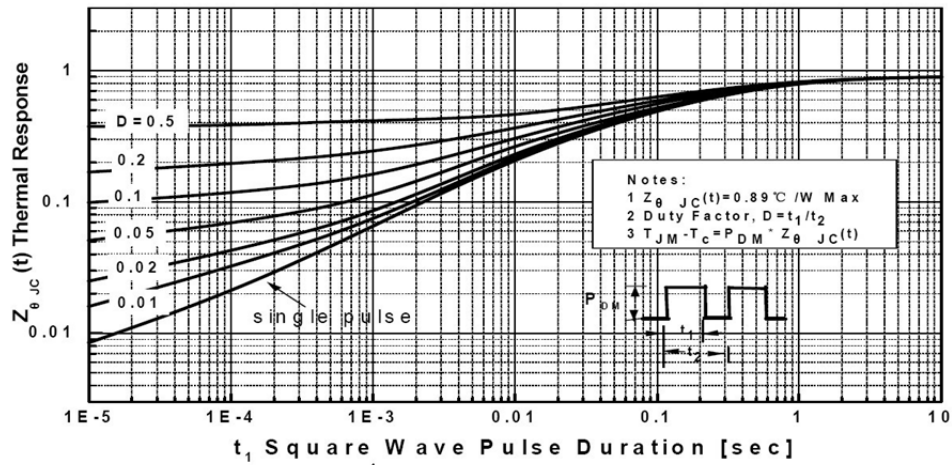

Fig. 9 Transient Thermal Response Curve(TO-220AB)

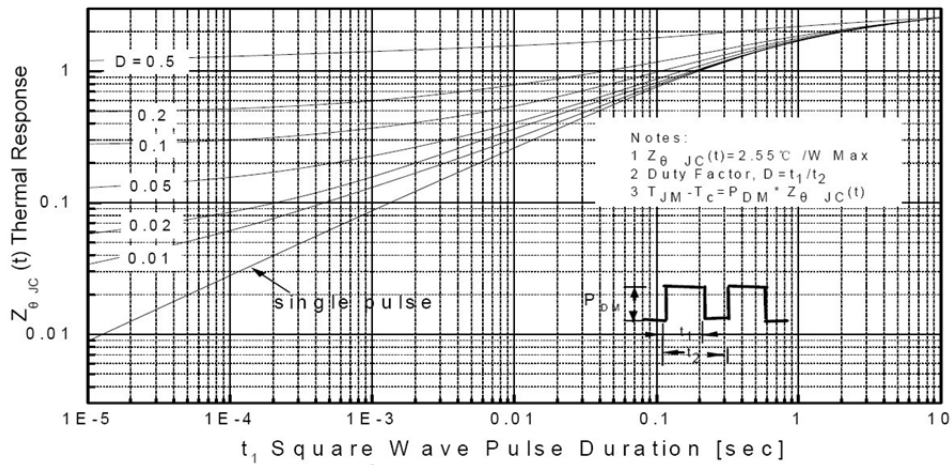
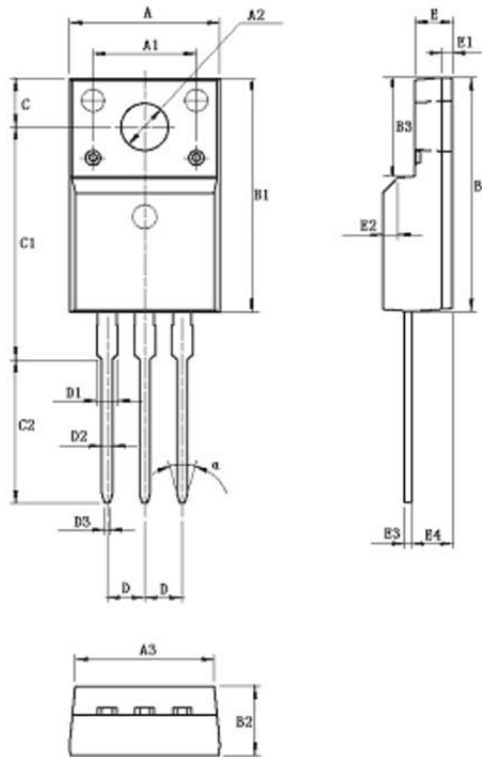

Fig. 10 Transient Thermal Response Curve(ITO-220AB)

■ Outline Dimensions

ITO-220AB



Symbol	Min	Max	Symbol	Min	Max
A	9.96	10.36	D	2.54	
A1	7.00		D1	1.15	1.35
A2	3.08	3.28	D2	0.70	0.90
A3	9.25	9.65	D3	0.28	0.48
B1	15.70	16.10	E	2.34	2.74
B2	4.50	4.90	E1	0.70	
B3	6.20	6.80	E2	1.0×45°	
C	3.20	3.40	E3	0.36	0.65
C1	15.20	16.00	E4	2.55	2.95
C2	9.75	10.15	a(度)	30°	

TO-220AB

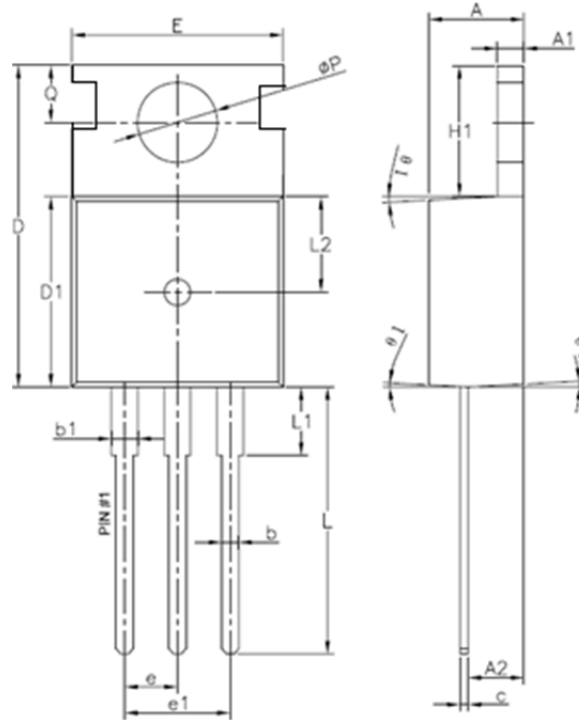

Symbol	Min	Normal	Max	Symbol	Min	Normal	Max
A	4.4	4.5	4.6	e		2.54	
A1	1.27	1.3	1.33	e1		5.08	
A2	2.3	2.4	2.5	H1	6.3	6.5	6.7
b	0.7	/	0.9	L	13.0	13.38	13.5
b1	1.25		1.42	L1	/	/	3.5
c	0.45	0.5	0.6	L2		4.6	
D	15.3	15.7	16.1	ΦP	3.55	3.6	3.65
D1	9.1	9.2	9.3	Q	2.73	/	2.87
E	9.7	9.9	10.2	$\theta 1$ ($^{\circ}$)	1	3	5



Disclaimer

The information presented in this document is for reference only. Yangzhou Yangjie Electronic Technology Co., Ltd. reserves the right to make changes without notice for the specification of the products displayed herein to improve reliability, function or design or otherwise.

The product listed herein is designed to be used with ordinary electronic equipment or devices, and not designed to be used with equipment or devices which require high level of reliability and the malfunction of which would directly endanger human life (such as medical instruments, transportation equipment, aerospace machinery, nuclear-reactor controllers, fuel controllers and other safety devices), Yangjie or anyone on its behalf, assumes no responsibility or liability for any damages resulting from such improper use of sale.

This publication supersedes & replaces all information previously supplied. For additional information, please visit our website <http://www.21yangjie.com> , or consult your nearest Yangjie's sales office for further assistance.