

## Surface Mount General Purpose Rectifier

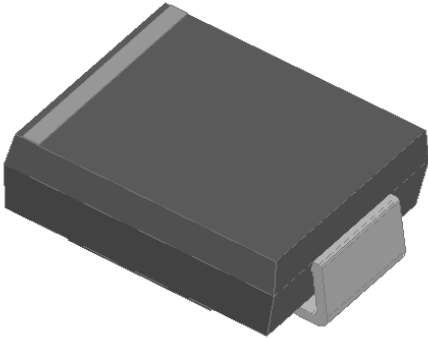

### Features

- High efficiency
- High current capability
- High reliability
- High surge current capability
- Low power loss
- Solder dip 260 °C max. 10 s, per JESD 22-B106
- Part no. with suffix "Q" means AEC-Q101 qualified

### Typical Applications

For use in general purpose rectification of power supplies, inverters, converters, and freewheeling diodes for consumer, automotive and telecommunication.

### Mechanical Data

- **Package:** DO-214AB (SMC)  
Molding compound meets UL 94 V-0 flammability rating, RoHS-compliant, halogen-free
- **Terminals:** Tin plated leads, solder able per J-STD-002 and JESD22-B102
- **Polarity:** Color band denotes cathode end

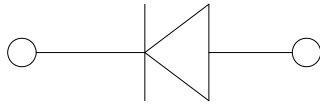

### ■Maximum Ratings (T<sub>a</sub>=25°C Unless otherwise specified)

PARAMETER	SYMBOL	UNIT	GS8AQ	GS8BQ	GS8DQ	GS8GQ	GS8JQ	GS8KQ	GS8MQ
Device marking code			GS8A	GS8B	GS8D	GS8G	GS8J	GS8K	GS8M
Repetitive Peak Reverse Voltage	V <sub>RRM</sub>	V	50	100	200	400	600	800	1000
Maximum RMS voltage	V <sub>RMS</sub>	V	35	70	140	280	420	560	700
Average Rectified Output Current @60Hz sine wave, Resistance load, T <sub>L</sub> (FIG.1)	I <sub>O</sub>	A	8.0						
Forward Surge Current (Non-repetitive) @60Hz Half-sine wave, 1 cycle, T <sub>a</sub> =25°C	I <sub>FSM</sub>	A	200						
Storage Temperature	T <sub>STG</sub>	°C	-55 ~+150						
Junction Temperature	T <sub>J</sub>	°C	-55 ~+150						

### ■Electrical Characteristics (T<sub>a</sub>=25°C Unless otherwise specified)

PARAMETER	SYMBOL	UNIT	TEST CONDITIONS	GS8AQ	GS8BQ	GS8DQ	GS8GQ	GS8JQ	GS8KQ	GS8MQ
Maximum instantaneous forward voltage drop per diode	V <sub>F</sub>	V	I <sub>FM</sub> =8.0A	1.1						
Maximum DC reverse current at rated DC blocking voltage per diode	I <sub>R</sub>	μA	T <sub>a</sub> =25°C	10						
			T <sub>a</sub> =125°C	250						
Typical junction capacitance	C <sub>J</sub>	pF	1MHz, V <sub>R</sub> =4V.	70					60	



# GS8AQ THRU GS8MQ

## ■ Thermal Characteristics (T<sub>a</sub>=25°C Unless otherwise specified)

PARAMETER		SYMBOL	UNIT	GS8AQ	GS8BQ	GS8DQ	GS8GQ	GS8JQ	GS8KQ	GS8MQ
Thermal Resistance	Junction to ambient	R <sub>θJ-A</sub>	°C/W	75 <sup>①</sup>						
	Junction to lead	R <sub>θJ-L</sub>		12 <sup>①</sup>						

Note(1)

Thermal resistance from junction to ambient and from junction to lead mounted on P.C.B. with 0.6" x 0.6" (16 mm x 16 mm) copper pad areas

## ■ Characteristics(Typical)

Fig.1: I<sub>O</sub>-T<sub>L</sub> Curve

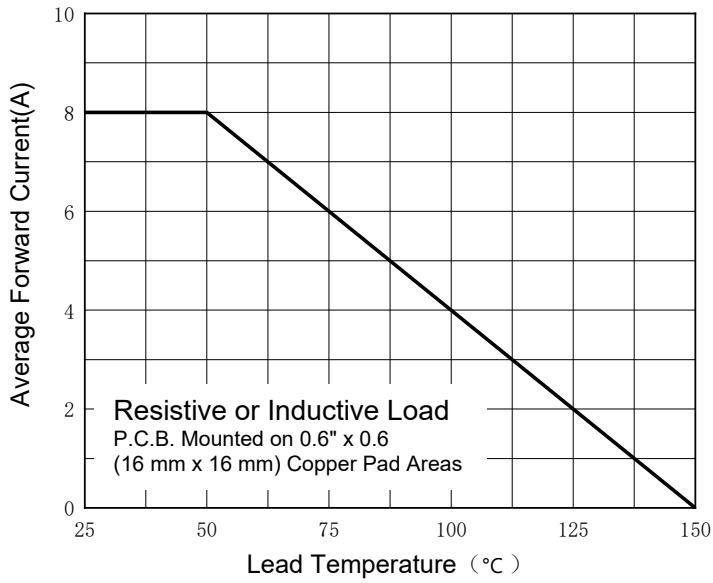

Fig.2: Surge Forward Current Capability

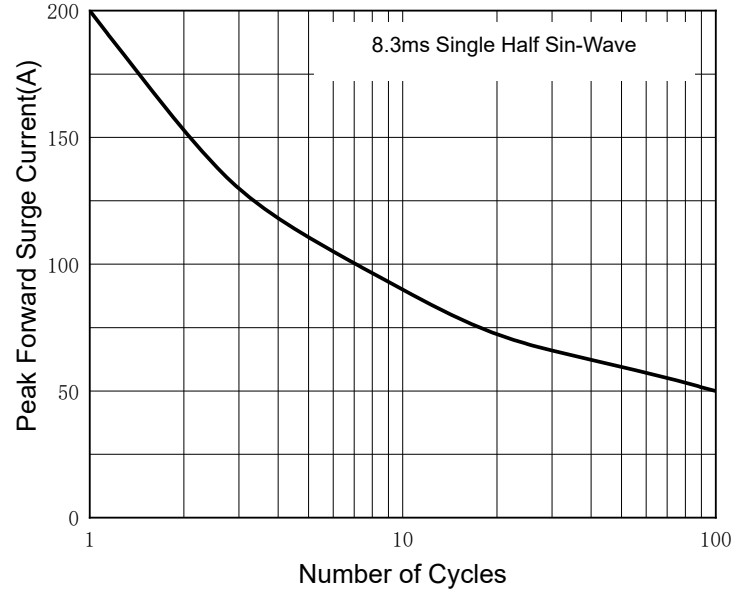

Fig.3: Typical Forward Characteristics

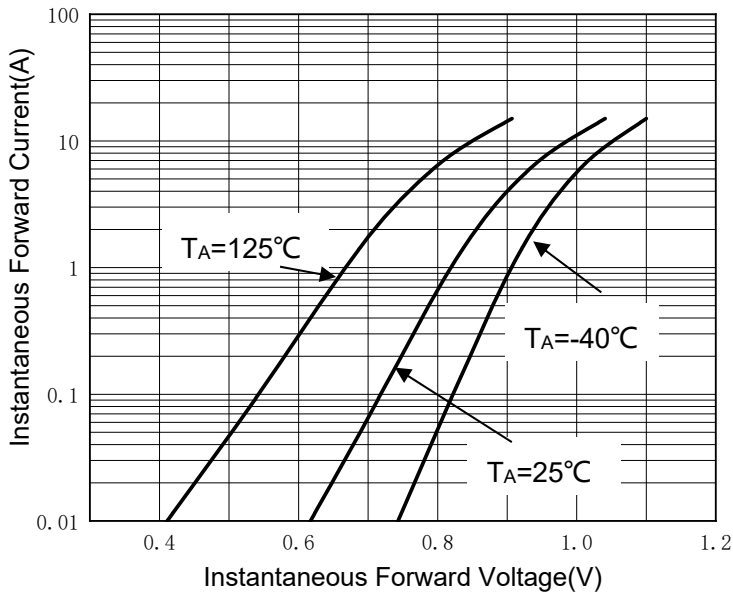
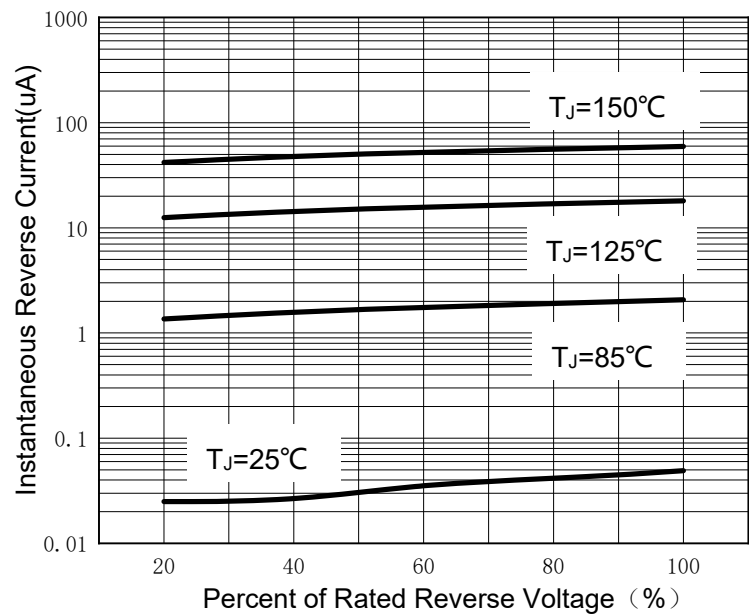

Fig.4: Typical Reverse Characteristics





# GS8AQ THRU GS8MQ

## Ordering Information (Example)

PREFERRED P/N	PACKAGE CODE	UNIT WEIGHT(g)	MINIMUM PACKAGE(pcs)	INNER BOX QUANTITY(pcs)	OUTER CARTON QUANTITY(pcs)	DELIVERY MODE
GS8AQ~GS8MQ	F1	Approximate 0.253	3000	6000	42000	13" reel

## Outline Dimensions

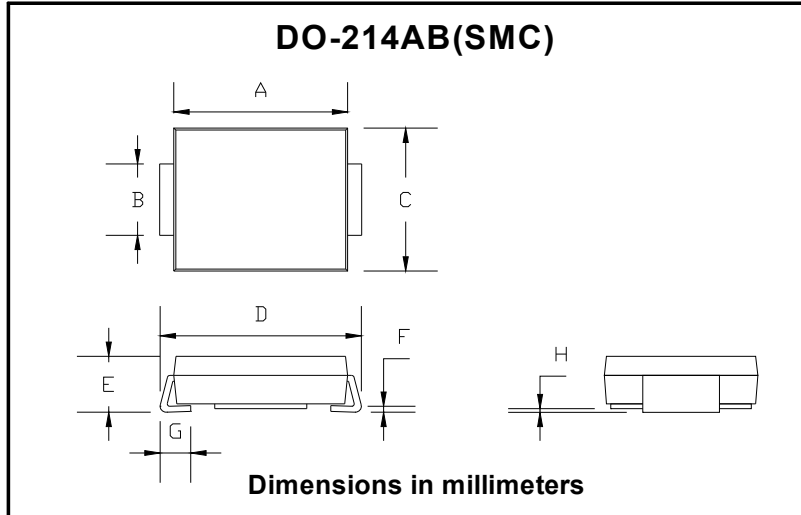

DO-214AB (SMC)		
Dim	Min	Max
A	6.60	7.11
B	2.85	3.27
C	5.59	6.22
D	7.75	8.13
E	1.99	2.61
F	0.15	0.31
G	0.76	1.52
H	0.10	0.20

## Suggested pad layout

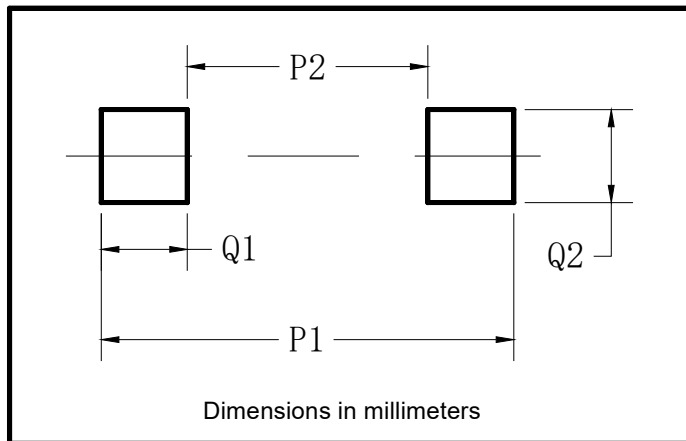

Dim	Typ
P1	9.9
P2	3.84
Q1	3.03
Q2	3.82



## GS8AQ THRU GS8MQ

---

### Disclaimer

The information presented in this document is for reference only. Yangzhou Yangjie Electronic Technology Co., Ltd. reserves the right to make changes without notice for the specification of the products displayed herein to improve reliability, function or design or otherwise.

The product listed herein is designed to be used with automotive electronics, are not designed for use in medical, lifesaving, lifesustaining, or military, Yangjie or anyone on its behalf, assumes no responsibility or liability for any damages resulting from such improper use of sale.

This publication supersedes & replaces all information previously supplied. For additional information, please visit our website [http:// www.21yangjie.com](http://www.21yangjie.com) , or consult your nearest Yangjie's sales office for further assistance.