

## NPN+PNP Digital Transistors (Built-in Resistors)

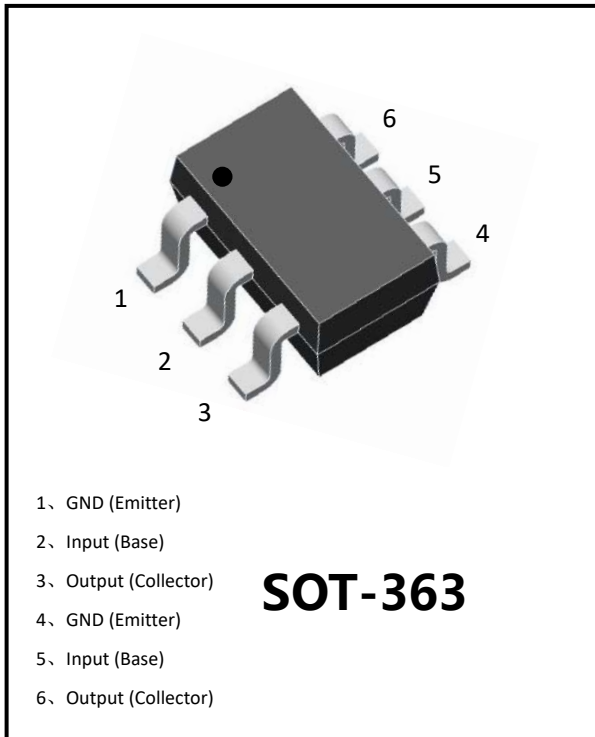

### Features

- Epoxy meets UL-94 V-0 flammability rating
- Moisture Sensitivity Level 1
- Built-in bias resistors enable the configuration of an inverter circuit without connecting external input resistors
- Only the on/off conditions need to be set for operation, making the circuit design easy
- Simplifies Circuit Design、Reduces Board Space、Reduces Component Count
- Part no. with suffix "Q" means AEC-Q101 qualified

### Application

- Control of IC inputs、Switching loads、Digital system

### Mechanical Data

- **Package:** SOT-363
- **Terminals:** Tin plated leads, solderable per J-STD-002 and JESD22-B102
- **Marking:** D22

### Equivalent circuit

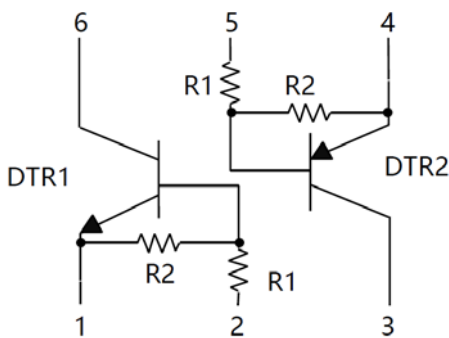



## UMD22NQ

### ■Maximum Ratings (Ta=25°C Unless otherwise specified)

#### DTR1-NPN

ITEM	SYMBOL	UNIT	VALUE
Collector-Emitter Voltage	$V_{CEO}$	V	50
Collector-Base Voltage	$V_{CBO}$	V	50
Emitter-Base Voltage	$V_{EBO}$	V	5
Supply Voltage	$V_{CC}$	V	50
Input Voltage	$V_{IN}$	V	-5 to +30
Collector Current	$I_C$	mA	100
Power Dissipation (*)	$P_D$	mW	150
Junction Temperature	$T_j$	°C	-55 to +150
Storage Temperature	$T_{STG}$	°C	-55 to +150

#### DTR2-PNP

ITEM	SYMBOL	UNIT	VALUE
Collector-Emitter Voltage	$V_{CEO}$	V	-50
Collector-Base Voltage	$V_{CBO}$	V	-50
Emitter-Base Voltage	$V_{EBO}$	V	-5
Supply Voltage	$V_{CC}$	V	-50
Input Voltage	$V_{IN}$	V	-30 to +5
Collector Current	$I_C$	mA	-100
Power Dissipation (*)	$P_D$	mW	150
Junction Temperature	$T_j$	°C	-55 to +150
Storage Temperature	$T_{STG}$	°C	-55 to +150

(\*) Device mounted on FR-4 PCB 1.0 x 1.0 x 0.06 inch



# UMD22NQ

## ■ Electrical Characteristics (Ta=25°C unless otherwise specified)

### DTR1-NPN

ITEM	SYMBOL	UNIT	CONDITIONS	MIN	TYP	MAX
Input voltage	$V_{I(off)}$	V	$V_{CC}=5V, I_O=100\mu A$	0.5	-	-
	$V_{I(on)}$	V	$V_O=0.3V, I_O=5mA$	-	-	1.3
Output voltage	$V_{O(on)}$	V	$I_O=5mA, I_I=0.25mA$	-	-	0.3
Input current	$I_I$	mA	$V_I=5V$	-	-	1.8
Output current	$I_{O(off)}$	$\mu A$	$V_{CC}=50V, V_I=0$	-	-	0.5
DC current gain	$G_I$		$V_O=5V, I_O=10mA$	80	-	-
Input resistance	$R_1$	k $\Omega$		3.29	4.7	6.11
Resistance ratio	$R_2/R_1$			8	10	12
Transition frequency	$f_T$	MHz	$V_{CE}=10V, I_C=5mA, f=100MHz$	-	250	-

### DTR2-PNP

ITEM	SYMBOL	UNIT	CONDITIONS	MIN	TYP	MAX
Input voltage	$V_{I(off)}$	V	$V_{CC}=-5V, I_O=-100\mu A$	-0.5	-	-
	$V_{I(on)}$	V	$V_O=-0.3V, I_O=-5mA$	-	-	-1.3
Output voltage	$V_{O(on)}$	V	$I_O=-5mA, I_I=-0.25mA$	-	-	-0.3
Input current	$I_I$	mA	$V_I=-5V$	-	-	-1.8
Output current	$I_{O(off)}$	$\mu A$	$V_{CC}=-50V, V_I=0$	-	-	-0.5
DC current gain	$G_I$		$V_O=-5V, I_O=-10mA$	80	-	-
Input resistance	$R_1$	k $\Omega$		3.29	4.7	6.11
Resistance ratio	$R_2/R_1$			8	10	12
Transition frequency	$f_T$	MHz	$V_{CE}=-10V, I_C=-5mA, f=100MHz$	-	250	-

## ■ Ordering Information (Example)

PREFERRED P/N	PACKING CODE	UNIT WEIGHT(g)	MINIMUM PACKAGE(pcs)	INNER BOX QUANTITY(pcs)	OUTER CARTON QUANTITY(pcs)	DELIVERY MODE
UMD22NQ	F2	Approximate 0.009g	3000	30000	120000	7" reel



## ■ DTR1 NPN Characteristics (Typical)

Fig.1 - ON Characteristics

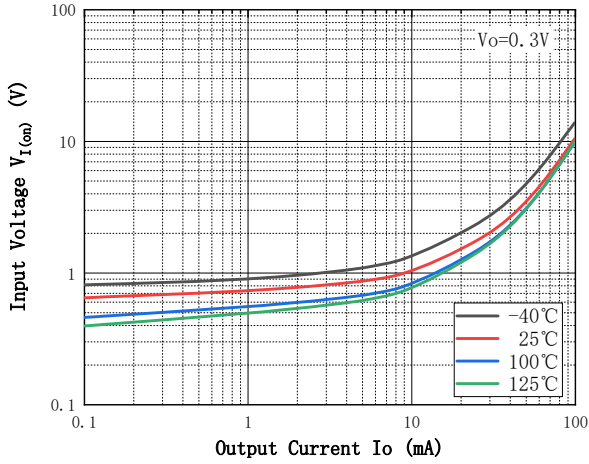

Fig.2 - OFF Characteristics

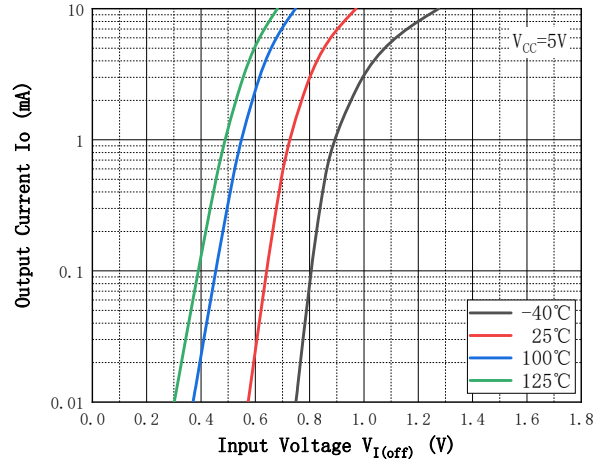

Fig.3 - Output Voltage Characteristics

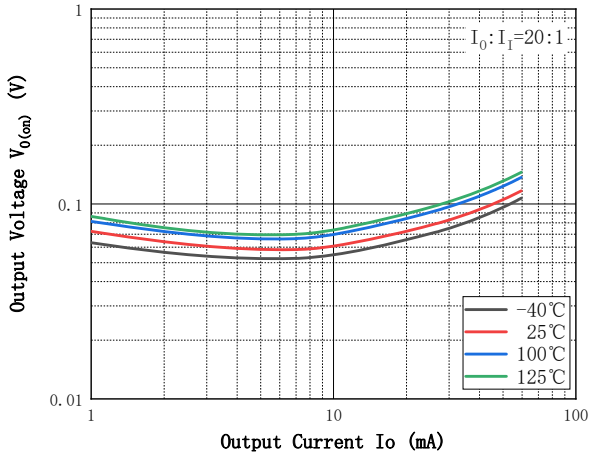

Fig.4 - DC Current Gain Characteristics

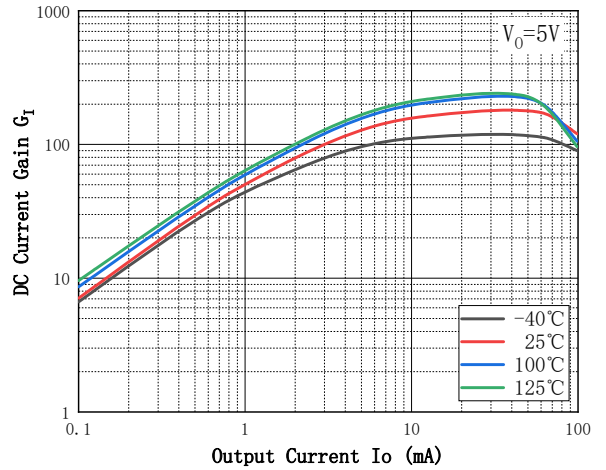
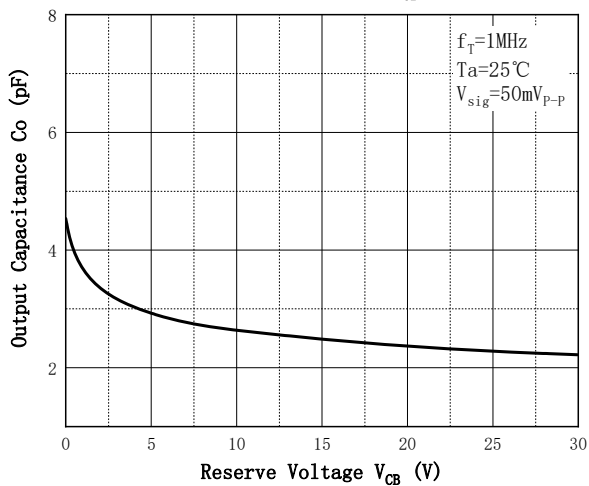

Fig.5 -  $C_o$  —  $V_{CB}$





■ DTR2 PNP Characteristics (Typical)

Fig.1 - ON Characteristics

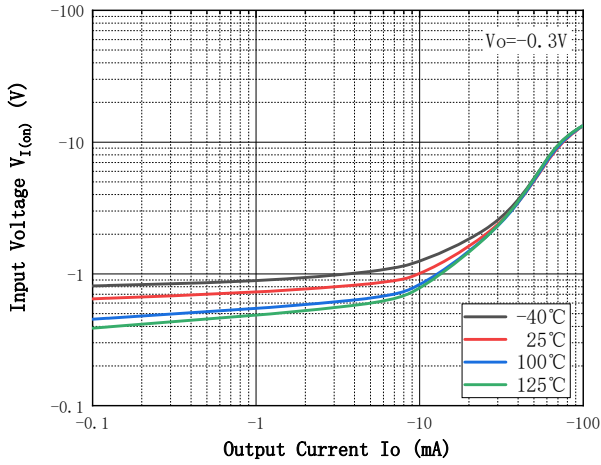

Fig.2 - OFF Characteristics

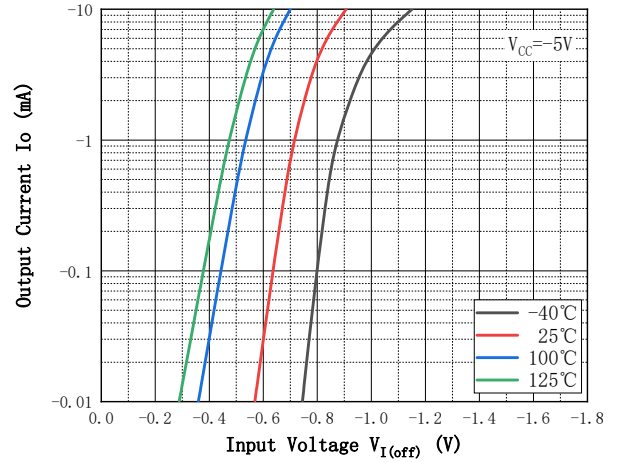

Fig.3 - Output Voltage Characteristics

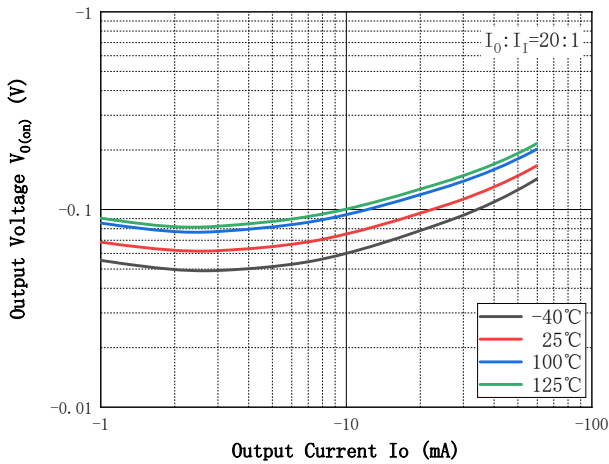

Fig.4 - DC Current Gain Characteristics

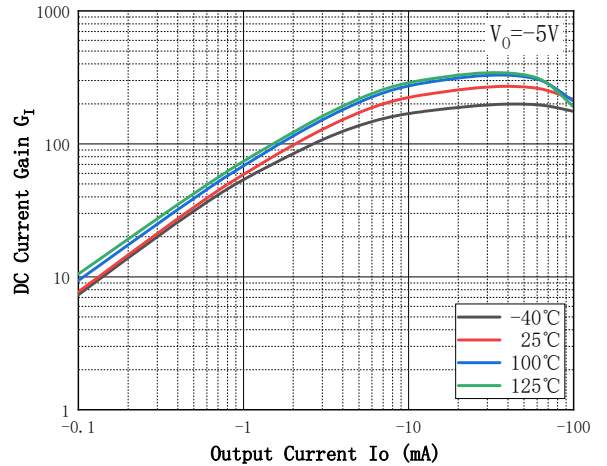
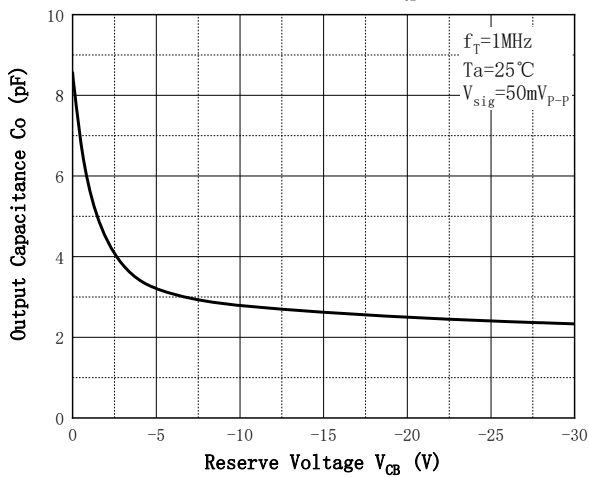

Fig.5 -  $C_o$  —  $V_{CB}$





# UMD22NQ

## ■SOT-363 Package Outline Dimensions & Suggested Pad Layout

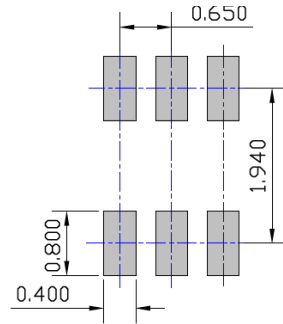
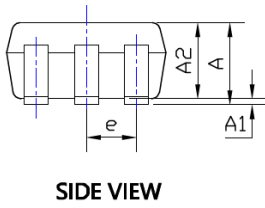
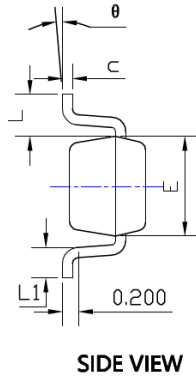
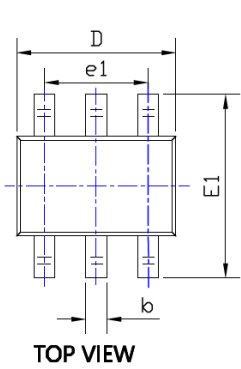

UNIT: mm

SUGGESTED SOLDER PAD LAYOUT

SYMBOL	DIMENSIONS			
	INCHES		Millimeter	
	MIN.	MAX.	MIN.	MAX.
A	0.035	0.043	0.900	1.100
A1	0.000	0.004	0.000	0.100
A2	0.035	0.039	0.900	1.000
b	0.006	0.014	0.150	0.350
c	0.004	0.010	0.100	0.250
D	0.071	0.087	1.800	2.200
E	0.045	0.053	1.150	1.350
E1	0.085	0.096	2.150	2.450
e	0.026TYP		0.650TYP	
e1	0.047	0.055	1.200	1.400
L	0.021REF		0.525REF	
L1	0.010	0.018	0.260	0.460
theta	0°	8°	0°	8°

**NOTE:**

1. PACKAGE BODY SIZES EXCLUDE MOLD FLASH AND GATE BURRS.
2. TOLERANCE 0.1mm UNLESS OTHERWISE SPECIFIED.
3. THE PAD LAYOUT IS FOR REFERENCE PURPOSES ONLY.



## UMD22NQ

---

### Disclaimer

The information presented in this document is for reference only. Yangzhou Yangjie Electronic Technology Co., Ltd. reserves the right to make changes without notice for the specification of the products displayed herein to improve reliability, function or design or otherwise.

The product listed herein is designed to be used with automotive electronics, are not designed for use in medical, life-saving, lifesustaining, or military, Yangjie or anyone on its behalf, assumes no responsibility or liability for any damages resulting from such improper use of sale.

This publication supersedes & replaces all information previously supplied. For additional information, please visit our website [http:// www.21yangjie.com](http://www.21yangjie.com) , or consult your nearest Yangjie's sales office for further assistance.